



TELEDYNE
OLDHAM SIMTRONICS
Everywhere you look™

MX 16

ANALOG AND DIGITAL CONTROLLER



User Manuals in other languages are available on Website
<https://teledynegasandflamedetection.com>



Copyright © April 2021 by TELEDYNE OLDHAM SIMTRONICS S.A.S. All rights reserved. The reproduction of all or any section of this document in any form whatsoever without the written permission of TELEDYNE OLDHAM SIMTRONICS S.A.S. is forbidden.

The information contained in this manual is accurate to our knowledge. As a result of continuous research and development, the specifications of this product may be modified at any time without prior notice.

TELEDYNE OLDHAM SIMTRONICS S.A.S.

Rue Orfila

Z.I. Est – CS 20417

62027 ARRAS Cedex

Table of contents

1	General Information.....	1
1.1	User Manual.....	1
1.2	Symbols used.....	1
1.3	Safety Instructions.....	2
1.4	Important Information	2
1.5	Liability Limits	3
1.6	Warranty.....	3
2	General Introduction	5
2.1	Purpose of the MX 16 controller.....	5
2.2	The different Versions.....	6
2.3	Firmpate	7
2.4	The COM 16 Software.....	8
3	Mechanical Installation	9
3.1	MX 16 Controller.....	9
3.2	Gas detectors	10
4	The MX 16 Controller	11
4.1	Overview of the Unit.....	11
4.2	Front Plate	14
4.3	Alarm Thresholds and Relays	16
5	Wiring and Electrical Connections.....	19
5.1	Controller Connection.....	19
6	Menus.....	23
6.1	General Menu Tree.....	23
6.2	Navigation Key Functions.....	24
6.3	Display in normal mode	24
6.4	Main Menu	25

6.5	System.....	26
6.6	Program.....	26
6.7	Calibration	27
6.8	4. Maintenance.....	30
6.9	5. Information.....	31
7	Main Part Numbers	35
8	Cleaning and maintenance.....	37
8.1	Cleaning	37
8.2	Fuse replacement.....	37
8.3	Replacement of the lithium battery	37
9	Certificate of Compliance	39
10	Technical Specifications.....	41
10.1	MX 16 Controller.....	41
11	RS485 Digital Output.....	45
11.1	Card description.....	45
11.2	Transfer Table	46
11.3	Address Table.....	47
12	Specific conditions of use and Functional Safety	53
12.1	Specific Conditions of Use	53
12.2	Specific instructions for the prevention of explosions.....	53
12.3	Connecting detectors other than <i>TELEDYNE OLDHAM</i> <i>SIMTRONICS</i> detectors to the MX 16 controller.....	54

1 General Information



WARNING: ALL INDIVIDUALS WHO HAVE OR WILL HAVE RESPONSIBILITY FOR USING, MAINTAINING, OR SERVICING THIS PRODUCT MUST READ THIS ENTIRE MANUAL CAREFULLY. FAILURE TO USE THIS EQUIPMENT PROPERLY COULD RESULT IN SERIOUS INJURY OR DEATH.

1.1 User Manual



The instructions given in this manual must be read thoroughly before installation and start-up, particularly those concerning the points related to the safety of the end-user. This user manual must be made available to every person involved in the activation, use, maintenance, and repair of the unit.



The information, technical data, and diagrams contained in this manual are based on the information that is available at a given time. In case of doubt, contact *TELEDYNE OLDHAM SIMTRONICS* for additional information.

The aim of this manual is to supply simple and accurate information to the user. *TELEDYNE OLDHAM SIMTRONICS* cannot be held liable for any misinterpretations in the reading of this manual. In spite of our efforts to produce an error-free manual, it may nonetheless contain some unintentional technical inaccuracies.

In the client's interest, *TELEDYNE OLDHAM SIMTRONICS* reserves the right to modify the technical characteristics of its equipment to increase their performance without prior notice. The present instructions and their content are the inalienable property of *TELEDYNE OLDHAM SIMTRONICS*.

1.2 Symbols used

Icon	Significance
	This symbol indicates useful additional information.
	This symbol indicates: Earth ground connection.
	This symbol denotes: Protective earth terminal. A cable of the adequate diameter must be connected to ground and to the terminal having this symbol.

Icon	Significance
	This symbol denotes: Attention! In the present mode of use, failure to adhere to the instructions preceded by this symbol can result in a risk of electric shock and/or death.
	This symbol indicates: You must refer to the instructions.
	European Union (and EEA) only. This symbol indicates that this product must not be discarded with household waste, as per the EEA directive (2002/96/EC) and your own national regulations. This product must be disposed of at a collection point that is reserved for this purpose, for example, an official site for the collection of electrical and electronic equipment (EEE) in view of their recycling, or a point of exchange for authorized products that is accessible when you acquire a new product of the same type.

1.3 Safety Instructions

Labels intended to remind you of the principal precautions of use have been placed on the unit in the form of pictograms. These labels are considered an integral part of the unit. If a label falls off or becomes illegible, please ensure it is replaced. The significance of the labels is detailed below.



The installation and electrical connections must be carried out by qualified personnel according to the instructions of the manufacturer and the standards of the competent authorities. Failure to adhere to the instructions can have serious consequences on the safety of persons. Please be extremely rigorous as regards electricity and assembly (coupling, network connections).

Cables with an operating temperature of 70°C minimum (158 °F) must be used because the temperature inside the controller can reach 70°C (158 °F).

1.4 Important Information

The modification of the material and the use of parts of an unspecified origin shall entail the cancellation of any form of warranty. The use of the unit has been projected for the applications specified in the technical characteristics. Exceeding the indicated values cannot in any case be authorized.

1.5 Liability Limits

Neither *TELEDYNE OLDHAM SIMTRONICS* nor any other associated company under any circumstances can be held liable for any damage, including, without limitations, damages for loss or interruption of manufacture, loss of information, defect of the *MX 16* controller, injuries, loss of time, financial or material loss, or any direct or indirect consequence of loss occurring in the context of the use or impossibility of use of the product, even in the event that *TELEDYNE OLDHAM SIMTRONICS* has been informed of such damage.

1.6 Warranty

Under normal conditions of use and on return to the factory, parts and workmanship carry a two year warranty, excluding consumables such as backup power supplies, audio and visible alarms, etc.

MX 16

ANALOG AND DIGITAL CONTROLLER
USER MANUAL

2 General Introduction

2.1 Purpose of the *MX 16* controller

This controller is intended for the continuous measurement and control of the gases present in the atmosphere.



Figure 1: *MX 16* and examples of the modules

The system primarily comprises :

- a *MX 16*,
- one analog or digital detector.

The *MX 16* instantly handles the measurements of detector. As soon as the measurements reach the configured thresholds, the internal buzzer and the LED indicators go off. At the same time, the corresponding relays are activated to drive the additional actions programmed by the user. The *MX 16* controller is programmed by using the *COM 16* configuration software. Figure 2 presents a configuration example.

MX 16

ANALOG AND DIGITAL CONTROLLER
USER MANUAL



Figure 2: Example of an *MX 16* configuration using one analog detector

2.2 The different Versions

The *MX 16* controller is available in Analog and Digital versions, configurable with *COM 16*:



The *MX 16* does not have an input for Wheatstone bridge sensors (*Wheatstone bridge version*).



The *MX16* does not manage *MX 32* and *MX 43* module as 8 analog input (AIM), 4 or 8 relais modules (ROM), 16 logic inputs (LIM) and 4 analog outputs.



Figure 3: *MX 16*

The following table details the different possible configurations depending on the controller's version. On each line, it is possible to connect 4-20mA analog detectors or digital addressable modules.

Version	Maximum Capacity
	Detectors
1 digital line	1
1 analog line	1

Table 1: Summary of the maximum capacity as per the controller type

2.3 Firmpplate

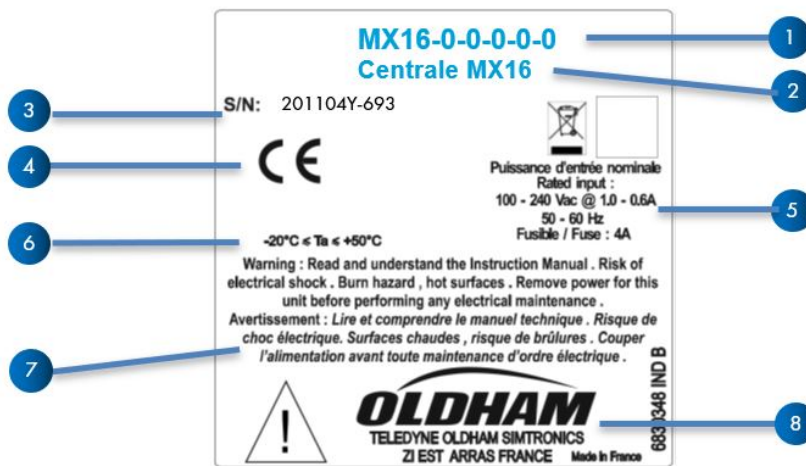

It contains relevant information with respect to the controller version.

MX 16

ANALOG AND DIGITAL CONTROLLER
USER MANUAL

Tag.	Description
1.	Product Name
2.	Part Number
3.	Serial Number. The first four digits (in this case 2011) correspond to the year and the month of manufacture (20 and 11 indicating manufacturing in November 2020)
4.	CE marking
5.	Electrical characteristic
6.	Operating temperature range
7.	Warnings
8.	Name and mail address of the Manufacturer

2.4 The *COM 16* Software

This is intended for setting the *MX 16* parameters from a Windows® operated PC. The operation and use of this application is covered in a special training course.

3 Mechanical Installation

3.1 *MX 16* Controller

3.1.1 Location The *MX 16* is intended for indoor use only and shall be installed in premises without explosive atmospheres, away from direct exposure to sunlight, and protected from humidity, dust, and temperature variations. It shall preferably be located in a monitored environment (for instance: guardhouse, control room, or instrument room, etc.).

3.1.2 Attachment of the wall enclosure Access to the controller must be ensured in order to facilitate adjustments, monitoring, and cabling. A space of 400 mm is necessary in front of the *MX 16* for opening the door. Use 3 fixing screws 4x25 mm for fixing the case support.

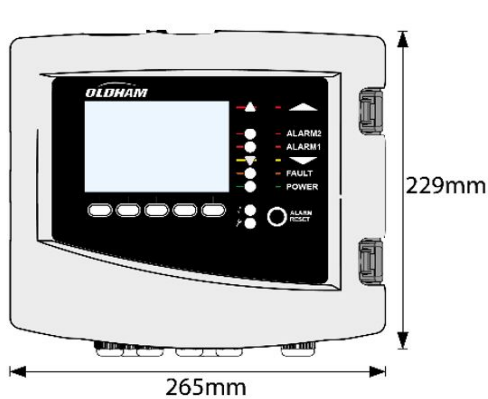

Figure 4: Dimensions

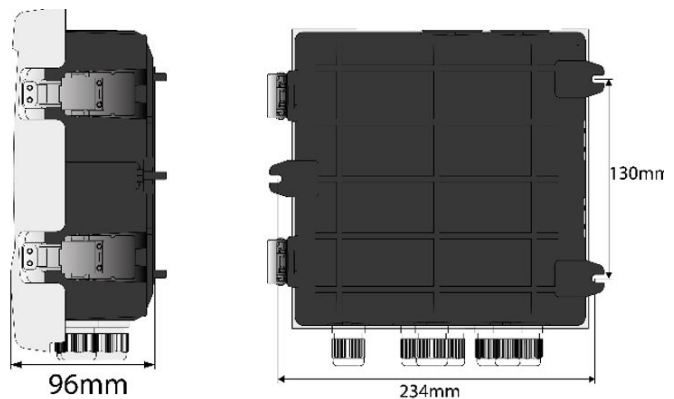

Figure 5: Fixing the *MX 16*

3.2 Gas detectors



Refer to the manual supplied with each detector.

3.2.1 Location

Each detector shall be positioned at ground level, on the ceiling, at human height or near air extraction ducts, depending on the density of the gas to be detected or the application. Heavy gases are detected close to the ground, while lighter gases are present along the ceiling. If necessary, contact *TELEDYNE OLDHAM SIMTRONICS* for any questions regarding proper detector positioning.

3.2.2 Fixing

The detectors shall preferably be positioned in an accessible place so that inspections and maintenance can be carried out as well as to ensure the absolute safety of the operators. The detectors must not be obstructed by anything that will prevent them from measuring the ambient environment to be checked.

4

4

4 The MX 16 Controller

4.1 Overview of the Unit

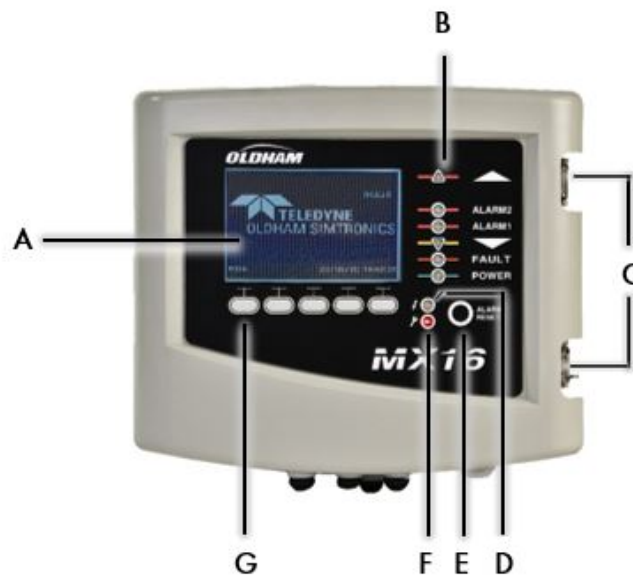

4.1.1 External view

Figure 6: External view

Rep.	Function	Rep.	Function
A.	Monochromatic, back-lit graphic LCD display	E.	Alarm Acknowledgement button
B.	Channel status indicator	F.	Failure/maintenance indicator
C.	Toggle Latch (one is lockable)	G	Contextual soft keys
D.	Power On/Off indicator		

MX 16

ANALOG AND DIGITAL CONTROLLER
USER MANUAL

4.1.2 Internal view

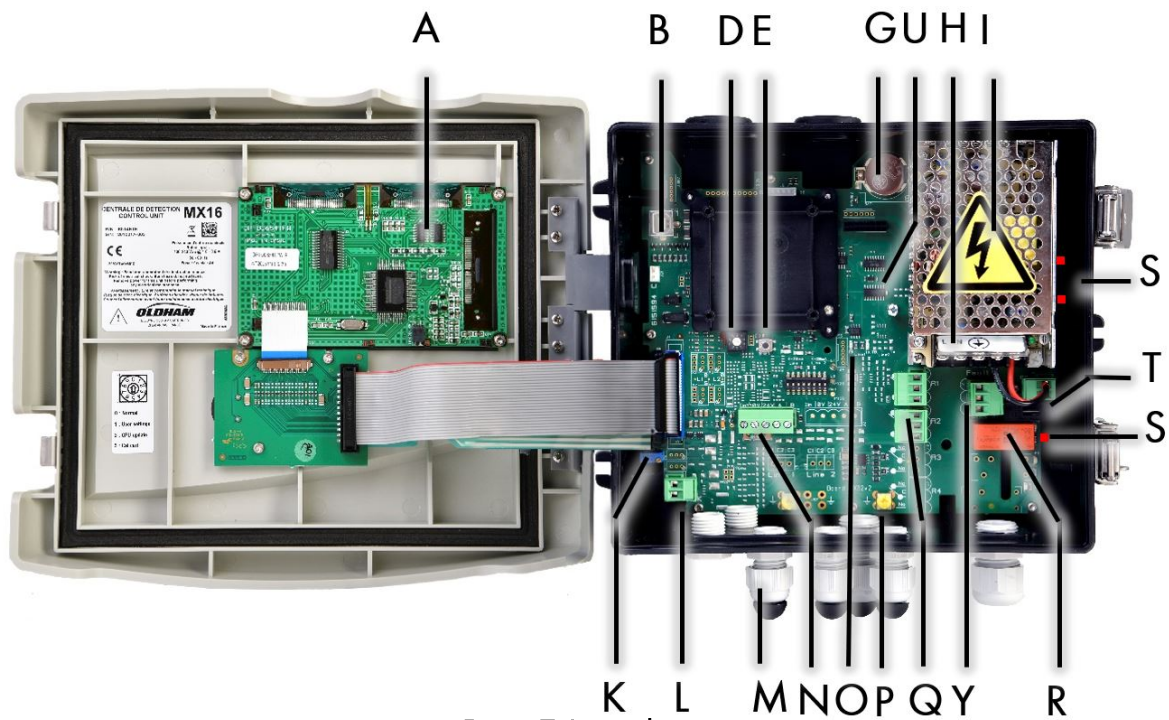



Figure 7: Internal view

Rep.	Function
A.	LCD graphic display card
B.	USB programmation port
D.	Programming (or mode) selector 0. <i>MX 16</i> in normal operation. 1. Read/Write configuration program 2. <i>MX 16</i> firmware update via a PC
	Once the unit configuration or update is complete, always set back the selector in the "0" position. The <i>MX 16</i> will resume automatically.
E.	Microcontroller reset button. Press this button to reset the controller.
G.	CR2032 lithium battery. Allows data and real time clock saving in case of power failure. Runtime is approx. 450 days while power off. Keep the <i>MX 16</i> powered during battery replacement.
H.	100-240Vac (50-60Hz) input terminal
I	100-240Vac / 24Vdc power supply (option)
K.	Display contrast setting
L.	Remote acknowledgement input terminal (NO dry relay contact)

Rep.	Function
------	----------

M	Cable glands; 5 x M16 + 2 x M20
---	---------------------------------

N	Line terminal
---	---------------

O. Digital communication status LED indicators (Line #1 on left, Line #2 on right). The information displayed by each pair of LEDs is interpreted as follows:

LED Status		Significance
Fast blinking	Fast blinking	Line is in normal operation mode- Tx: sends queries to the attached modules - Rx: receives data from attached modules
Irregular blinking	Irregular blinking	Bad communication quality with at least one module.
Blinks 1 time per sec	Off	Communication failure. Absence or failure of one module On communication failure, the internal buzzer, the failure indicator and the Fault relay are activated.
Off	Off	No active module is present on the line

P.	Grounding terminals to connect cable shield for digital and analog connections
----	--

Q	From top to bottom, relay alarm terminals (R1 to R2 respectively). DPCO relays, contacts rating 250Vac-30Vdc / 5A
---	---

R. Fault and Alarms relays (2 relays are located under the power supply; tag I). From top to bottom:

- Fault (Fault relay, non-configurable)
- R1, R2 (alarm relays, configurable)

Configuration of Alarm Relays Alarm relays are to be programmed with *COM 16* software. The PCB printing displays while unpowered. R1 to R2 relays can be configured as normally energized (the coil is powered when not in alarm) or normally de-energized (the coil is powered when in alarm). There are different way to program the relays:

- Normal mode: relay operates as the alarm sequence. The sure can set a delay and chose the relay to be latched or unlatched (see Alarm Acknowledgement, page 17).
- Buzzer mode: This mode is usually used for audible alarms management. The ‘buzzer’ relay acts as a ‘normal’ relay but can be acknowledged even if the alarm is still present (in order to turn the siren off).

The time delays are:

MX 16

ANALOG AND DIGITAL CONTROLLER
USER MANUAL

Rep.	Function
.	Reset Inhibit: Minimum time of activation, adjustable from 0 to 900 seconds.
.	Automatic reset: Time adjustable between 15 and 900 seconds, beyond which the buzzer relay is automatically deactivated.
.	Reactivation time: Time adjustable between 15 and 900 seconds, beyond which the buzzer relay is automatically reactivated if the alarm is still present.
Alarm Relay Management by the logic operators OR, AND, NOR, NAND. The result of the equation controls the relay.	
S.	Relays status DEL indicator. Illuminated when the corresponding relay coil is ON.
T.	4 Amp fuse, protects the 24V power supply input
U.	Modbus RS485 communication board (option, see page 45)
Y.	Faut relay terminal. DPCO relay, 250Vac-30Vdc / 5A

4.2 Front Plate

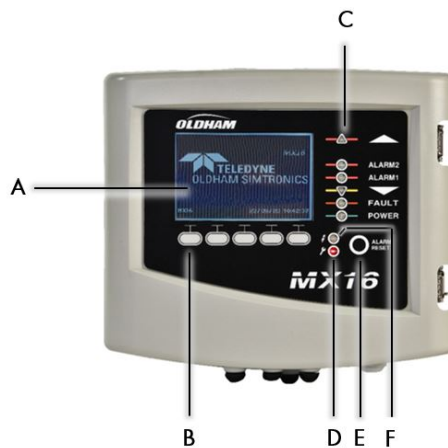

Figure 8: MX 16's front plate

4.2.1 LCD (A)

The display shows the measurement or the settings menus. When an alarm occurs, the display turns in grayscale mode to indicate the channel is on alarm.

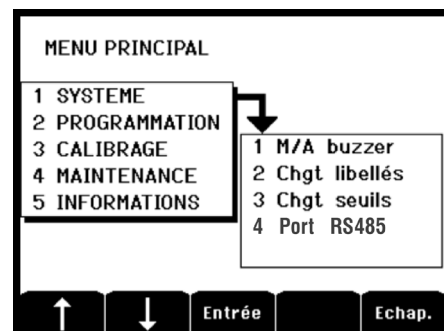
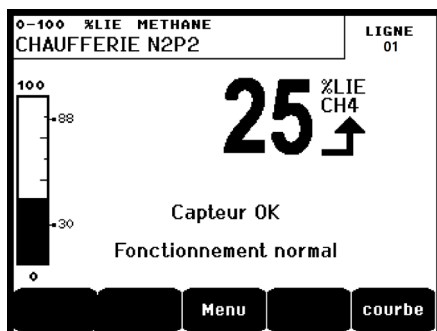

Figure 9: Display of the measurement (on the left) or parameter settings display (on the right)

Refer to paragraph *Menus* on page 23 for more details about the information that are available on the screen.

4.2.2 Contextual Keys (B)

The function of each of the 5 keys indicated in the lower part of the display changes depending on the page displayed.

Zone Status Indicators (C)



Each bar displays the status of the group of detectors of the pertinent zone as follows:

Icon	Function
▲	<p>Orange indicator of high-range excess (OVS: overscale, high-range excess). This value is adjustable up to 110% of the range.</p> <ul style="list-style-type: none"> Off: The measurement is lower than the OVS value programmed. Lit: The measurement is higher than the OVS value programmed. The alarm relays are activated in accordance with the program. In parallel, the display indicates « > ». <p>OVS acknowledgement must be done manually and is only possible if the current value drops below the programmed value. <i>Management of "Non-Ambiguity Reading"</i> The <i>Non-Ambiguity Reading</i> function only applies to the monitoring of flammable gases in a range of 0-100%LEL, and is subject to the decision of the operator. Upon the detection of a concentration of gas higher than 100% LEL, the LCD indicates <i>> 100% LEL – Frozen value – High Concentration - System in Fault Condition</i>. The OVS and FAILURE indicators are activated. Such an alarm can only be deactivated by turning off the detector via the maintenance menu once the current gas level is below the programmed OVS limit.</p>
ALARM	Off: No alarm
2ALARM	- Solid: at least one gas detector of the corresponding zone is in alarm condition. Acknowledgment is programmed in automatic mode or the alarm reset button located on the front panel has already been pushed.
1	- Blinking: at least one gas detector of the corresponding zone is in alarm condition. Acknowledgment is programmed in manual mode and has not been required yet.
▼	<p>Orange indicator of low- range excess (UDS: Under scale, low-range excess). This value is adjustable from 0-10% of the range.</p> <ul style="list-style-type: none"> Off: The measurement is higher than the UDS value programmed. Lit: The measurement is lower or equal than the UDS value programmed. The alarms of the relays are activated in accordance with the programming. In parallel, the display indicates « < ». <p>Reset of the UDS is automatic once the failure is fixed.</p>

Icon	Function
FAULT	<p>Orange failure indicator Off: No Fault</p> <ul style="list-style-type: none"> • Solid: Communication problem with one of the modules or invalid detector measurement, that is to say either below -10% of the range or above 110% of the range. • Blinking: Controller in maintenance mode (test, calibration). <p>Reset of the FAULT is automatic once the failure is fixed.</p>
POWER	<p>Green start/stop indicator for the detectors/modules of the zone. Off: All detectors of the corresponding zone have been turned off</p> <ul style="list-style-type: none"> • Solid: At least one detector of the corresponding zone is communicating <p>Blinking: Detailed information of one detector of the corresponding zone are currently displayed on the LCD screen.</p>

4.2.4 Status indicators (D and F)

These two indicators reflect the status of the *MX 16*.

Icon	Function
	<p>Green indicator denoting the power supply status Solid: Voltage input is OK</p> <ul style="list-style-type: none"> • Off: Voltage input is below 22Vdc
	<p>Failure/maintenance orange indicator Off: No failure detected</p> <ul style="list-style-type: none"> • Solid: Presence of some failure (controller, detector, communication, memory). The alarm clears automatically once the failure is fixed. • Blinking: <i>MX 16</i> in maintenance mode (test, calibration).

4.2.5 Alarm Reset Key (E)

Press this key to silence the on-board buzzer and reset the alarms that can be acknowledged. This reset button can be remote, see paragraph *Remote Acknowledgement connector* on page 22.

4.3 Alarm Thresholds and Relays

Alarm thresholds, relay programming, time delays setting, alarm acknowledgement modes or the management of the additional flash and sounder are configured through *COM 16* application. Note: It is possible to modify a programmed alarm level via the *MX 16's* user interface (*Program* menu).

4.3.1 Internal Relays and Buzzer

- 2 Fully configurable Alarm relays are available.

- 1 Fault relay is available. This relay is not configurable and is activated on the appearance of any failure. The Fault relay is powered in normal operation mode so it does switch over in the event of a power supply failure.
- The internal buzzer is activated on the appearance of any event (failure or alarm). The sound differs depending on the event: continuous in fault mode, discontinuous in alarm mode and frequency increases according to the alarm level that is reached. The internal buzzer can be deactivated permanently through the user interface or COM 16 application.

4.3.2 Alarms Settings It is possible to program for the detector: 2 alarm levels

- each alarm can be increasing or decreasing
- each alarm can be configured as an instantaneous alarm
- each alarm has an adjustable hysteresis from 0 to +3% of the measuring range by increments of 1%
- one over range alarm (OVS: over scale)
- one under range alarm (UDS: underscale)
- one "no ambiguity" alarm (for flammable gas detectors and concentrations above 100% LEL)

Alarms may be programmed for automatic or manual acknowledgement (except OVS, UDS, "no ambiguity").

4.3.3 Alarms Automatic Acknowledgement In this mode, resetting an alarm does not require any intervention. Alarm management (relays, visual indicators, buzzer) is as follows:

Event	Display	Alarm Relay (normal mode)	Alarm Relay (buzzer mode)	Alarm LED	Internal buzzer
Alarm Appearance	AL (1,2) grayscale mode	Activated	Activated	Solid	ON
Alarm Resets pressed	AL (1,2) grayscale mode	Activated	Deactivated	Solid	OFF
Alarm Disappearance	Normal mode	Deactivated ^(a)	Deactivated ^(a)	OFF	(b)

(a): Automatic deactivation upon alarm disappearance even if Alarm Reset button was not pressed

(b): Manual acknowledgement (press Alarm Reset) is mandatory to silence the internal buzzer

Table 2: Alarms in Automatic Acknowledgement mode

4.3.4 Alarms Manual Acknowledgement

In this mode, Alarms must be reset by the operator. Alarm management (relays, visual indicators, buzzer) is as follows:

Event	Display	Alarm Relay (normal mode)	Alarm Relay (buzzer mode)	Alarm LED	Internal buzzer
Alarm Appearance	AL(1,2) grayscale mode	Activated	Activated	Blinking	ON
<i>Alarm Resets</i> pressed	AL(1,2) grayscale mode	Activated if event is still present	Deactivated	Solid if event is still present	OFF
	AL(1,2) grayscale mode	Deactivated if the event has disappeared	Deactivated	OFF if the event has disappeared	OFF
Alarm Disappearance	Normal mode ^(a)	Deactivated ^(a)	Deactivated ^(a)	OFF ^(a)	OFF ^(a)

(a): Once Alarm Reset button has been pressed

Table 3: Alarms in Manual Acknowledgement mode

5 Wiring and Electrical Connections

This chapter details the electrical connections of all components of the system (*MX 16*, additional equipment).

5.1 Controller Connection

The electrical connections must be carried out by qualified personnel in compliance with the different directives in force in the country of installation.



The *MX 16* does not have a start/stop switch.

Certain voltage levels are capable of causing serious injuries or even death. It is advised to install the material and cabling before applying live voltage.

Since an incorrect or poor installation may cause measurement errors or system failures, it is necessary to strictly follow all the instructions in this manual in order to guarantee the proper operation of the system.

Certified strain relief bushing required. Utilized cords shall comply with all certified bushing specifications.

Suitable external cords shall be used in the end application and shall be according to local rules/standards for *MX 16* product.

Cables with an operating temperature of 70°C minimum (158 °F) must be used because the temperature inside the controller can reach 70°C (158 °F).

5.1.1 Access to terminal blocks

After unlocking the two toggle latches, swing the front cover towards the left in order to access the wiring terminal.

5.1.2 100-240 Vac Power Supply

The *MX 16* can be powered from a 100-240Vac source at 50/60 Hz, 1.5A max. Check the nature of the current and the voltage value prior to any connection. The electrical connections must be carried when power is down.

A bipolar differential circuit breaker, 4A, type C, must be included in the installation as means for disconnection. It must be suitably located and easily reached and must be marked as the disconnecting device for the *MX 16*.

MX 16

ANALOG AND DIGITAL CONTROLLER USER MANUAL

The main power shall be connected to the terminal block as indicated in Figure 10. The ground conductor shall be connected to the ground terminal . Connect earth before connecting L/N conductors. Disconnect earth after disconnecting L/N conductors.

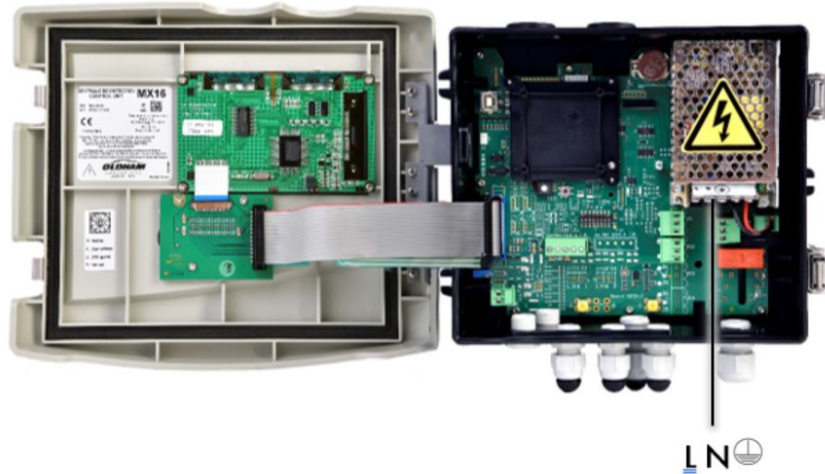

Figure 10: Connection of the main power supply

5.1.3

5.1.3 Grounding The *MX 16* meets EMC and Low Voltage Directives requirements. In order to fully comply with the class of protection, it is absolutely necessary to connect the ground terminal to the Earth of the site (Figure 11, A). Moreover, the cable braids of the digital and analog lines shall also be connected to this ground terminal.

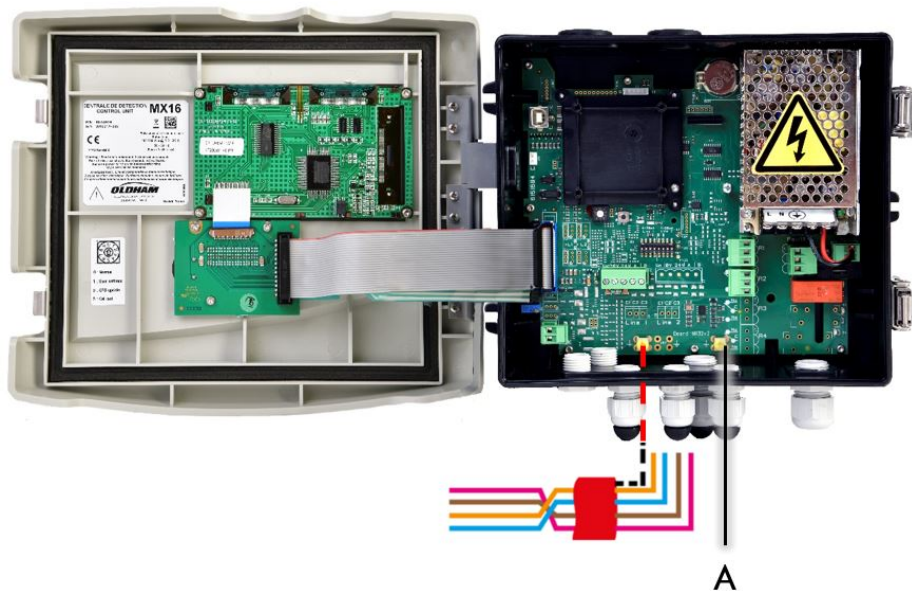

Figure 11: Ground and braid connection

5.1.4 Digital line The cabling of the digital lines connecting the controller to the detector deployed along the line is the subject as follows. It should be remembered that this cable comes in 2 twisted pairs of 4 x 0.22 m² minimum, type MPI-22A, nominal impedance of 100 Ohms.

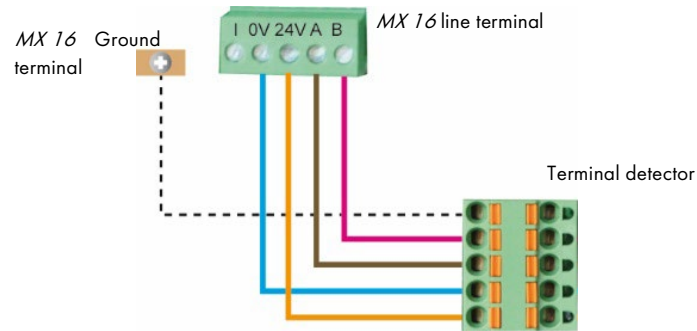

Figure 12 : Wiring a digital detector to MX16

5.1.5 Analog line

For an analog 4-20mA detector connected directly to the *MX 16* line, please wire the detector as shown below.

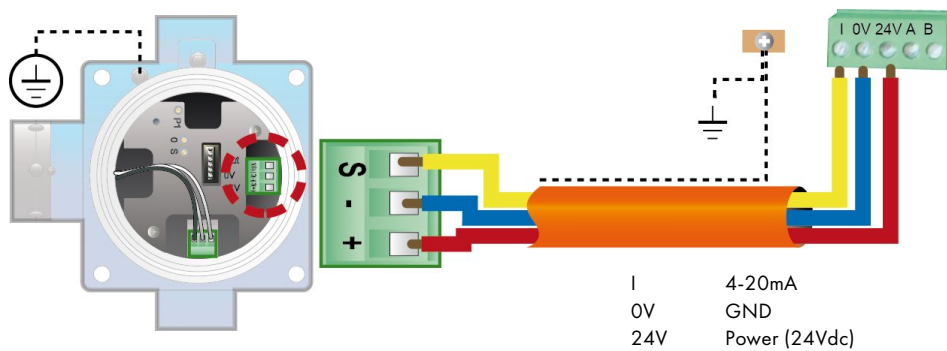

Figure 13: 4-20mA detector connected to an analog line

5.1.6 Internal alarm relays

The *MX 16* has 5 internal relays:

Output	Function
R1	Programmable Alarm Relay
R2	Programmable Alarm Relay
Failure :(Fault)	Non-programmable common relay, energized, activated upon the presence of a failure in the <i>MX 16</i> (detector and/or module, system failure, etc.). The acknowledgement of this relay is automatic.

The dry relay contacts (nominal resistive load of 5A at 250Vac or 30Vdc) are identified as R1, R2 (Figure 14, tag A) and Fault (Figure 14, tag B).

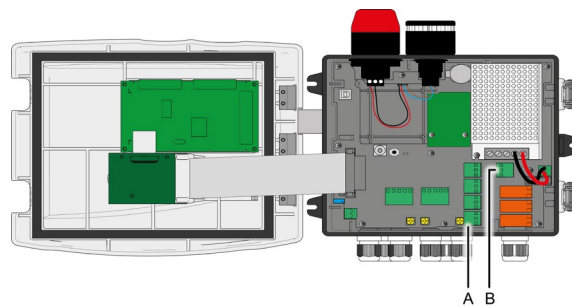

Figure 14: Internal alarm relays (A) and fault relay (B) terminals



The relay contacts are represented when no power applies to the *MX 16*. The relays are programmed via the *COM 16* application and can be set as energized or de-energized.

5.1.7 Remote Acknowledgement Connector

If necessary, connect the ACQUIT (dry contact relay, NC) terminal to a remote acknowledgement system.

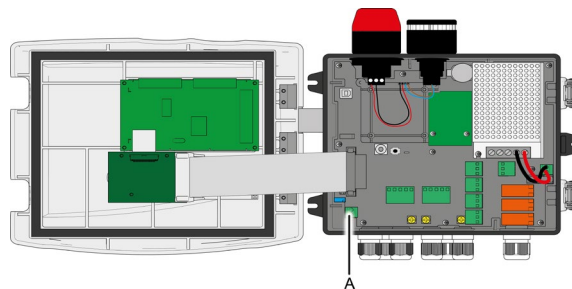

Figure 15: Remote acknowledgement connection (A).

6 Menus

6.1 General Menu Tree

The following figure shows the general tree of the group of menus.

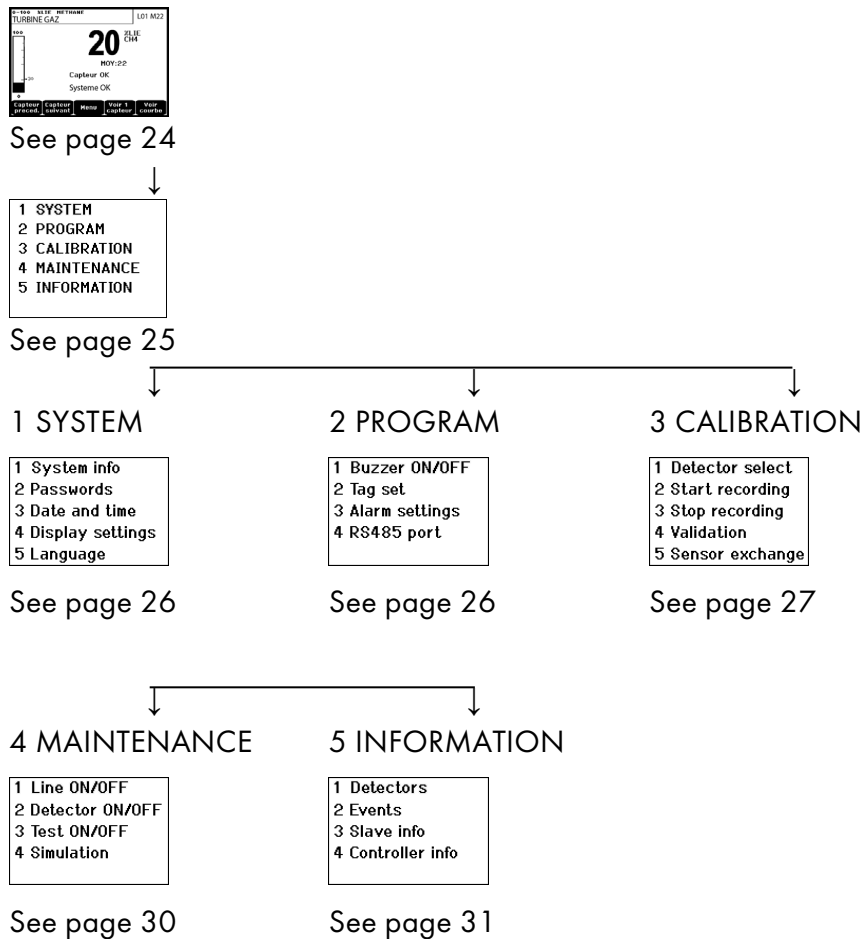

Figure 16: General menu tree of the MX 1616

6.2 Navigation Key Functions

Key	Function
↑↓	Vertical displacement in the selected menu block.
→←	Horizontal displacement between two menu blocks.
Enter	Validation of the selected line.
Escape	Return to previous screen.

Table 4: Function of the navigation keys

6.3 Display in normal mode Measurement Display

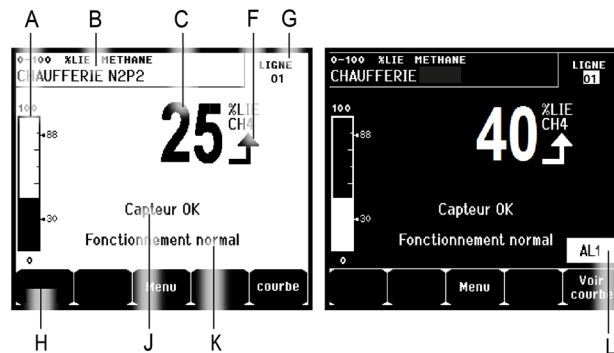

Figure 17: Example of the measurement display in normal mode and in grayscale mode

Ref.	Significance
A.	Barograph with an indication of alarm limits.
B.	Measurement range, gas detected, and detector language.
C.	Value of the current measurement with the unit and gas detected.
F.	Indicator of measurement trend ↑ Ascending tendency ↓ Descending tendency
G.	Address of digital detector on a digital line or channel number for a analog detector

Ref.	Significance
H.	Function keys. <ul style="list-style-type: none"> ■ Menu: Display of main menu See paragraph "Main menu" on page 25. • ■ Curve: Display of the measurement curves of the last 10 days (Figure 18). The → and ← keys allow cursor displacement through the time scale. The vertical dotted line displays the concentration and time stamp of the point being considered. Escape: return to display of values.
J.	Information on the detector status.
K.	Information on the <i>MX 16</i> status.
L.	Zone of indication of activated alarms with blinking threshold display. The screen changes to inverse video (Figure 17).

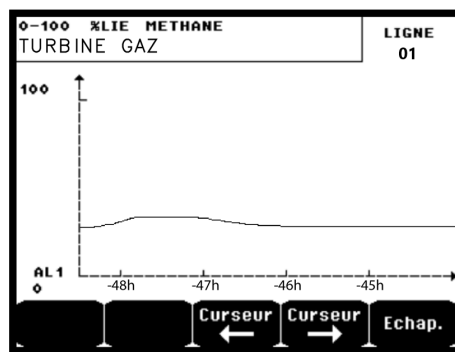

Figure 18: Example of a curve display screen

6.4 Main Menu

This displays all the management menus of *MX 16*.

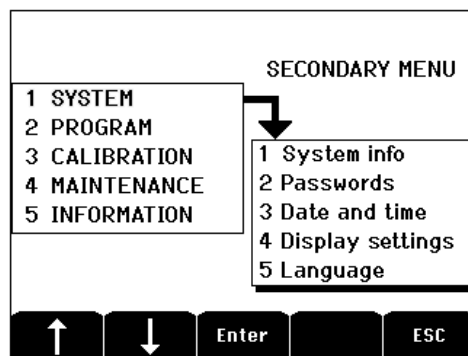

Figure 19: Main menu

6.5 System

- 1. System Info Displays the version of the program, the *bootloader* (internal micro-software for loading the program), and the configuration, as well as software application verifications.

- 2. Passwords The controller is protected by two access codes, both set at 1000 by default upon leaving the factory. You can change the passwords in this menu via *COM 16*. The passwords are required each time you enter one of the menus that they protect. ***First-level password:*** Authorizes access to the Calibration menu.

Second-level password: Authorizes access to the Programming, Calibration, and Maintenance menus. This password is also required before menu data are deleted.

- 3. Date and time Time stamp settings (year, month, day, hour, minute, second).

- 4. Display settings *Scrolling display*
 - OFF: the display is frozen on a selected detector.
 - ON: scrolls through detectors every two seconds.
By zone
 - ON: displays all detectors assigned to the same zone (same bar of leds).
 - OFF: displays all connected detectors regardless the zone they are assigned to.
Screen saver
 - OFF: *no screen saver.*
ON: turns into the screen saver mode (displays TELEDYNE OLDHAM SIMTRONICS logo) if no key is pressed for a certain period of time

- 5. Language Selection of the display menu language.

6.6 Program

- 1. Buzzer On/Off Activates or deactivates the internal buzzer of the *MX 1616*.

- 2. Tag set Allows for the modification of detector tags previously programmed via *COM 16*.

- 3. Alarm settings Allows for the modification of detector alarms previously programmed via *COM 16*.

- 4. Port RS485 Configuration of Port RS485 (speed, parity, stop bits, slave number). This configuration is only useful if the *MX 16* is equipped with the RS485 communication card.

6.7 Calibration



If the measurement cell has changed, it is important to declare this through a menu no. *5 Cell change*.

6.7.1 1. Detector select.

This menu enables the selection of detectors to be calibrated (calibration from *MX 16* or on the detector).

- A. Display of information described by the *COM 16* application: i.e., measurement range, gas detected, current detector ID and its type.
- B. Display for the current detector:
 - **Last passed calibration:** Date and time of the last calibration carried out and completed.
 - **Last sensor replacement:** Date and time of last cell change.
 - **Wear rate:** Relation between the value of the standard gas and the value read (sensitivity measurement). A wear rate in excess of 100% entails a sensor replacement.
- C. Display of the address (digital detector) or line number (analog detector) to which the detector is connected.
- D. Press **Cal gas** to enter its value by means of the ↑↓ keys. Validate by pressing **Enter**.
 - *Note: Only analog detectors that are not equipped with a local display can be calibrated from the MX 16 controller. For the other detectors, the menu "Sel. Detector" only makes it possible to put them in calibration mode so that they do not activate alarms during their manual calibration.*
 - Press **Escape** to launch the procedure of recording the measurements on the detectors to be calibrated. Proceed to paragraph "2 Recording".

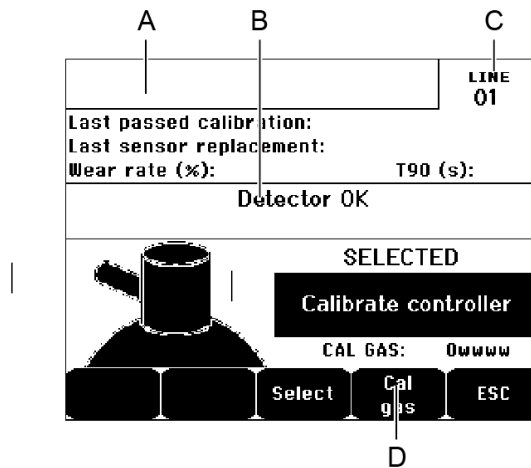

Figure 20: Example of the "Select detectors" screen

6.7.2 2. Start Recording

- **Yes:** Launches the recording of calibration measurements for the detector. From this moment onwards, all the calibration measurements are recorded for the detector. "Start recording" is then displayed. The calibration of the detectors with the help of the standard gas can begin.

For a detector in which the cell has been changed, it is important to adjust the detector locally to obtain a 4-20mA output corresponding to the detector range.

Attention: During calibration, the standard gas must be injected for at least thirty seconds.

- **No:** Exits the recording procedure

6.7.3 3. Stop recording

- **Yes:** Detector calibration having finished, this validates the end of calibration measurement recording for the detectors previously selected. From this moment onward, no calibration measurement is recorded. "Stop recording" is then displayed.
- **No:** Exits the end of the recording procedure.

6.7.4 4. Validation

This allows the adjustment and validation of zero and detector sensitivity once calibration is completed.

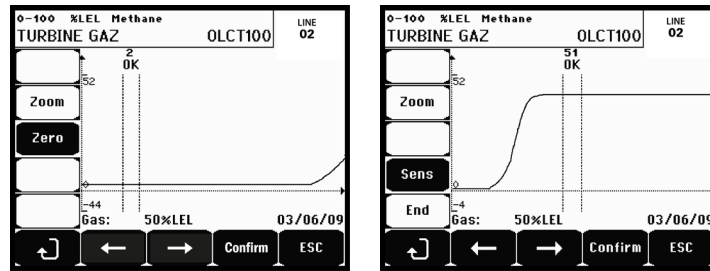

Figure 21: Adjustment of zero (left) and sensitivity (right)

Operating mode

1. Press **Validate**.

Zero calibration

1. The **Zoom** command is active.
2. Select the area of interest of the curve with the ← and → keys. Press **Zoom +** up to the activation of the Zero command. Adjust the position of the cursor so as to make the "OK" appear, in turn indicating that the range selected is sufficiently stable.
3. Press ↵ to select the term **Zero**.
4. Confirm the zero calibration by pressing **Validate zero**.
5. The term **Sens** (for sensitivity) is active from now on.

If sensitivity is not to be calibrated, press ↵ and **END**; until you see the message "Do you only want to calibrate zero for the detector?", then press **Validate calibration**. Only the zero calibration of the detector will have been carried out.

If sensitivity is to be calibrated, proceed directly to the following paragraph.

Sensitivity calibration

1. The **Sens** command is active.
2. Select the area of interest of the curve with the ← and → keys. Press **Zoom +** up to the activation of the command Sens. If applicable, adjust the position of the cursor so as to make the "OK" appear, in turn indicating that the range that has been selected is sufficiently stable.
3. Confirm the sensitivity calibration by pressing **Validate Sens**.

Record the calibration

1. The message "Do you want to validate zero and detector sensitivity?" is displayed. Press **Validate calibration** to confirm the adjustment of zero and sensitivity or **Esc** to exit the procedure.
2. The detector is calibrated.

6.7.5 5. Sensor exchange

This function reboots the parameters (rate of wear, calibration date, internal parameters corresponding to the 4-20mA range, etc.) from the detector following or in view of a change of cell.

Detector Selection

1. Select the detector to be rebooted with the help of the **Previous detector**, and **Next detector** keys and press **Select**.

Initialization of the Detector

1. Press Escape to reset the selected cells
2. Proceed with the cell replacement and then calibrate locally the corresponding detectors
3. Proceed with the calibration from the *MX 16* via the menus "1 Sel detectors", "2 recording", "End recording" and "4 validation" in order to save data calibration (wear rate, date of calibration, response time, etc.).

6.8 4. Maintenance*Access*

Successively press the keys **Menus** and **Maintenance**.

6.8.1 1. Line On/Off

Sets the line to stop (the line is not powered and the detectors are at stop; no event can be generated from then on).

6.8.2 2. Detector On/Off

Sets the detector to stop (no event can be generated from then on) if it was not issuing an alarm or failure.

6.8.3 3. Test On/Of

This allows for the verification of the proper operation of a detector. In this mode, recordings and alarm relays are suppressed.

6.8.4 4. Simulation

Upon its selection, the message “The controller no longer ensures detection” is displayed.

- The controller no longer keeps account of inputs (detector).
- The simulation measurements/status are initialized to the current measurement/status values. The relays, the internal buzzer, and the analog outputs remain in their current status.
- The screens, management of relays are those of Normal operation.
- The internal relay and the common default LED are activated.
- To change the value of a detector, use the ↓↑ keys to increase or decrease the measurement value simulated from –15% to 115%.
- The banner of alarms does not appear.
- The events log indicates Begin Simulation and End Simulation.
- Exit the simulation mode by pressing the End simul key. Automatic release then occurs. The current measurements are displayed once more.

6.9 5. Information

6.9.1 1. Detector

This displays the main information on the detector (type, range, detected gas).

6.9.2 2. Events

Alarm events					
TURBINE GAZ	AL1	ON	08 01 10	11:40:01	
TURBINE GAZ	AL1	OFF	08 01 10	15:16:40	
Previous page	Next page	Last page	Delete	ESC	

Figure 22: Example of gas alarm records

1. Alarm events

This displays, for the detector: ID, alarm type (AL1, AL2, OVS), status (activated = ON or deactivated = OFF) as well as the date and time of occurrence or of the release.

The letter “S” appears on the line if the events were obtained when the *MX 16* was in simulation mode. **Delete** deletes all the data. Up to 512 events can be memorized. Beyond that, the most recent event deletes the oldest. **Previous page**, **Next page**, and **Last page** access the corresponding pages of the file.

Message	Significance
AL1	Detector in level 1 alarm

AL2	Detector in level 2 alarm
OVS	Detector in OVS alarm

Table 5: Gas alarm file messages.

2. Fault records

This displays, for the detector c: event type (UDS = Under-scale), RANGE = measurement out of range, DEF =Failure, DOUBT = clear doubt), status (activated = ON or deactivated = OFF) as well as the date and time of appearance or release. This file cannot be deleted.

Message	Significance
UDS	The measurement is lower or equal to the value of the UDS programmed.
DEF	Detector failure (out of range, line cut, defective cell, etc.).
RANGE	Measurement out of range.
>> LEL	Concentration higher than 100% of LEL.

Table 6: Failure file messages

3. Relays records

This displays, for each relay concerned: activated relay/input ID, type (REL = relay), its status (activated = ON, Deactivated = OFF) as well as the date and time of occurrence or release. **Delete** allows for the deletion of this entire file. Up to 512 events can be memorized. Beyond that, the most recent event deletes the oldest. **Previous page**, **Next page**, and **Last page** access the corresponding pages of the file.

Message	Significance
RELAY	Status change of the designated relay.

Table 7: Relay and logic input file messages.

4. Working conditions records

This displays the actions carried out on the *MX 16* (simulation mode, calibration mode, programming mode, release request, operation on internal battery), as well as the date and time of beginning and end of the event. **Delete** allows for the deletion of this entire monitoring file. Up to 512 events can be memorized. Beyond that, the most recent event deletes the oldest. **Previous page**, **Next page**, and **Last page** allow access to the corresponding pages of the file; each page can display a maximum of 8 lines.

Message	Significance
Line 1 On/Off	Start or stop line 1
Detectors On/Off	Start or stop the detector
External ack.	Press the external acknowledgement button

Message	Significance
<i>MX 16</i> ack	Acknowledgement by the acknowledgement button on the front plate of <i>MX 1616</i>
Simulation	Switch to simulation mode
Calibration	At least one of the detectors is selected in calibration mode.
Test detectors	Switch to test mode
Program	Programming done on <i>MX 1616</i>
Time settings	Time settings on <i>MX 1616</i>

Table 8: Operation monitoring file messages.

5. Hardware troubles records

This displays, for each material incident detected: incident ID, status (activated = ON or deactivated = OFF) as well as the date and time of occurrence or release of the event. **Previous page**, **Next page**, and **Last page** allow access to the corresponding pages of the file: each page can display a maximum of 8 lines.

Message	Significance
DEAD	Digital module no longer responding (line cut, module failure, wrong address, module absent).
MODUL	Configuration or module address error.
TEMP+	Internal temperature of the <i>MX 16</i> higher than maximum tolerated value.
TEMP-	Internal temperature of the <i>MX 16</i> lower than maximum tolerated value.
LINE 1	Incident on line 1 (short-circuit).
CAL O	Calibration defect (zero shifted).
CAL S	Calibration defect (used cell).
CAL F	Calibration defect (cell oversensitive).
CAL D	Calibration defect (measurement unstable).

Table 9: Material incidents file messages

6. System troubles records

This displays the events relative to *MX 16* operation (power failure/fluctuation, On/Off, etc.). **Previous page**, **Next page**, and **Last page** allow access to the corresponding pages of the file; each page can display a maximum of 8 lines.

Message	Significance
ON	<i>MX 16</i> on live voltage

OFF	<i>MX 16</i> off voltage
Self-testing failure	Failure of internal tests
Other messages	Contact Post-Sales Service

Table 10: System incidents file messages

6.9.3 3. Slave info



These data enable maintenance technicians to visualize the communication framework between *MX 16* and the digital detector.

6.9.4 4. Controller info

These data allow technicians to visualize different counters such as number of resets on low voltage input, error system, configuration, etc.

7 Main Part Numbers

Reference	Description
MX16-0-0-0-0	Controller MX16, Analog or digital
MX16-0-0-1-0-0	Controller MX16, Analog or digital, with RS485 output

Description	Reference	Image
RS485 communication board	6 451 680	
100-240Vac/24Vdc Power Supply	6 314 210	
Fuse F7 (4A time-delay, 8.4A for 120 seconds - 250Vac)	6 154 738	
CR2032 lithium battery	6 111 321	

MX 16

ANALOG AND DIGITAL CONTROLLER
USER MANUAL

8 Cleaning and maintenance

8.1 Cleaning

Do not use alcohol- or ammonia-based liquids to clean the controller. If necessary, clean the exterior of the enclosure with a damp cloth.

8.2 Fuse replacement



Fuse replacement should only be performed by qualified personnel and power must be first switched off.

Fuses shall comply with IEC 60127 standard (time-delay fuse, low breaking capacity, 250Vac). Please see Chapter 7.

8.3 Replacement of the lithium battery

Lithium battery replacement should only be performed by qualified personnel and with an identical battery (see Chapter 7 for the list of spare parts). The controller must be first switched off. Power on the controller once the battery has been replaced.



TELEDYNE OLDHAM SIMTRONICS does not allow any other repairs than those listed here above.



Burn hazard. As the temperature inside the controller can reach 70°C (158 °F), it should be allowed to cool after aperture.

MX 16

ANALOG AND DIGITAL CONTROLLER
USER MANUAL

9 Certificate of Compliance

The document hereafter (1 page) reproduces the EU declaration of conformity.

**TELEDYNE**
OLDHAM SIMTRONICS
Everywhereyoulook™**DECLARATION UE DE
CONFORMITÉ****EU CONFORMITY
DECLARATION**

Réf : UE_MX16_rev A.doc

Nous,
We,**Teledyne Oldham Simtronics S.A.S., ZI Est, 62000 Arras France**Déclarons, sous notre seule responsabilité, que le matériel suivant :
*Declare, under our sole responsibility that the following equipment :***Centrale de mesure MX16 (MX16 Controller)**Est conçu et fabriqué en conformité avec les Directives et normes applicables suivantes :
*Is designed and manufactured in compliance with the following applicable Directives and standards:***I) Directive Européenne CEM 2014/30/UE du 26/02/14: Compatibilité Electromagnétique**
*The European Directive EMC 2014/30/UE dated from 26/02/14: Electromagnetic Compatibility*Normes harmonisées appliquées :
*Harmonised applied Standards***EN 50270 : 2015 for type 2****II) Directive Européenne DBT 2014/35/UE du 26/02/14: Basse Tension**
*The European Directive LVD 2014/35/UE dated from 26/02/14: Low Voltage*Normes harmonisées appliquées :
*Harmonised applied Standard***EN 61010-1 : 2010**Ce matériel ne doit être utilisé qu'à ce pour quoi il a été conçu et doit être installé en conformité avec les règles applicables et suivant les recommandations du fabricant.
This equipment shall be used for the purpose for which it has been designed and be installed in accordance with relevant standards and with manufacturer's recommendations.

A Arras, le 23/09/2020 (Arras, Sept 23rd, 2020)

Teledyne Oldham Simtronics S.A.S.
Z.I. EST - C.S. 20417
62027 ARRAS Cedex - FRANCE
Tel. : +33(0)3 21 60 80 80
www.teledyneGFD.comAM. Dassonville
Certification Responsable

Page 1 | 1

10 Technical Specifications

10.1 *MX 16* Controller

Function	
Function	Gas Detection Controller
Number of lines	1 (1 detector)

Display and indicators	
Display	Back-lit graphic LCD
Status indicators	<ul style="list-style-type: none"> - 6 LEDs - 1 Power On/Off visual indicator - 1 General failure indicator

Keys	
Selection	5 multifunction soft-touch keys
Alarm release	Dedicated soft-touch key

Alarms	
Limits	Parameter setting by <i>COM 16</i> application
Indicators	5 status LEDs per line (high- and low-range excess, Alarm 2, Alarm 1, failure)
Internal relay	<ul style="list-style-type: none"> ■ 4 fully programmable relays (configuration over <i>COM 16</i>) ■ 1 failure relay (non configurable) ■ DPCO relays, contact rating: 5A/250Vac-30Vdc ■ Screw terminals. Can accept 2.5 mm² (14AWG) wire

MX 16

ANALOG AND DIGITAL CONTROLLER
USER MANUAL

Electrical characteristics

AC power supply	■ 100 to 240Vac, 50/60 Hz
	■ Maximum 24Vdc output current 1.5A with derating (see next page)

Mechanical characteristics

Installation	■ Wall-mounted format. Indoors use only.
Dimensions (wxhxd)	■ 265 x 266 x 96 mm (10.4 x 10.5 x 3.8 inches)
Weight	■ 1,8 kg (3,97 Lbs)
Ingress Protection	■ IP55
Locking	■ 2 toggle latches (one can be locked)

Environmental characteristics

Temperature of use	-20 to +50°C, -4°F to +122°F (depending on power consumption)
Storage temperature	-20 to +50°C, -4°F to +122°F
Humidity	5 to 95% relative humidity, non condensing
Pressure, Altitude	Atmospheric pressure +/-10%. 2000m max altitude.
Storage	1 year then risk of data loss and memory time loss

Standards

Electromagnetic Compatibility	as per EN50270:15, industrial type 2
Low Voltage Directive	as per EN61010-1:10

Measurement Lines

Digital lines	■ 1 maximum
	■ RS485 Modbus, 9600 Bauds
	■ 4 wire serial cable, 2 shielded twisted pairs (1 for the line and 1 for communication)
Analog lines	■ 1 maximum
	■ Input range 4 to 20 mA
	■ Load resistance 120 Ohms
	■ Analog transmitter cable 2 or 3 shielded wires

Nominal voltage	22 to 28 V on external DC
Maximum load	■ 1A total with internal AC power according to T_{amb} below
Maximum power supply output power ($P_{out-max}$) depending on ambient temperature T_{amb}	<p>$P_{out-max}$ requires derating (in order to maintain a constant internal temperature) with $0.7W/^{\circ}C$ above $T_{amb} = 30^{\circ}C$ when powered by internal AC/DC power supply as following:</p> <ul style="list-style-type: none"> ■ for $T_{amb} \leq +30^{\circ}C$, $P_{out-max} = 32W$ <i>(1A external load for both lines)</i> ■ for $+30^{\circ}C \leq T_{amb} \leq +40^{\circ}C$, $P_{out-max} = 32W$ to $25W$ <i>(max. 0.71A external load for both lines at $+40^{\circ}C$)</i> ■ for $+40^{\circ}C \leq T_{amb} \leq +50^{\circ}C$, $P_{out-max} = 25W$ to $18W$ <i>(max. 0.42A external load for both lines at $+50^{\circ}C$)</i>
(AC power supply only)	
Cable glands	<ul style="list-style-type: none"> ■ 3xM16 cable glands for cables from 4 to 8 mm² ■ 2xM20 cable glands for cables from 6 to 12 mm²
Insulation	1500Vac (100-240Vac/24Vdc Power Supply)
Terminals	Screw terminals. Can accept 2.5 mm ² (14AWG) wire

MX 16

ANALOG AND DIGITAL CONTROLLER
USER MANUAL

11 RS485 Digital Output

The *MX 16* units using the *RS485 Modbus* option are equipped with a communication card (code 6451680), which is affixed to the motherboard. This card generates a RS485 output in *Modbus RTU* format.

11.1 Card description

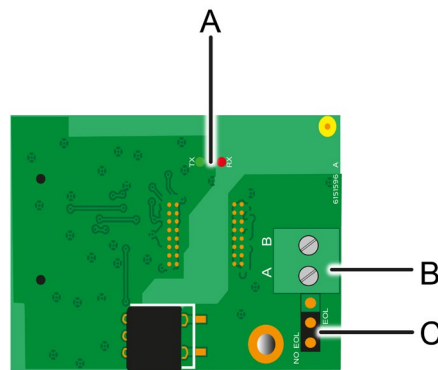

Figure 23: RS485 card

Rep.	Function
A.	Operating LEDs. The <i>Rx</i> LED lights up when a data thread is received. The <i>Tx</i> LED indicates that the card has power and turns off when data is being transmitted out.
B.	Connection terminal: A = Tx or +RS485 B = Rx or -RS485
C.	End Of Line (EOL) resistance. Set the switch to the EOL position for the unit that is the last module in the RS485 network. For other units, set the switch to NO EOL.

The RS485 output can be configured using the *COM 16* software, or using unit menu *2.4 Program >RS485 Port* (see page 26).

11.2 Transfer Table

Two types of information can be retrieved *via* the RS485 output:

- Information about sensor configuration;
- Real-time sensor information (measurements, alarms, etc.).

11.2.1 1. Access to configuration information

It is possible to access the installation configuration (for example, to access the alarm thresholds or the names of the sensors).

This configuration information is listed in the transfer table from address 0 to address 1999.

The address of the detectors is determined as follows:

- For a digital sensor:
Sensor address = 1
- For an analog sensor:
Sensor address = 257

Once the sensor address is known, the desired request can be executed by following the transfer table below. For example, to find the instantaneous alarm threshold number 1 for a sensor, read register number 52.

All of the information at addresses 1 to 52 will be accessed. The 52nd word corresponds to the expected value.

Example

Access instantaneous alarm 1 for the sensor located on line 2 at address 2 of unit 2.

A. Determination of the sensor address: 1

B. Structure of the *Modbus* request:

- | | |
|--|------------|
| - Slave number for the unit (defined by <i>factory</i>) | 02 = 0x02 |
| - Operating type (03 = read) | 03 = 0x03 |
| - Sensor address | 1 = 0x0001 |
| - Number of words to read (see Excel document) | 52 = 0x3A |
| - CRC | |

Thread: 0x02 0x03 0x00 0x22 0x00 0x3A 0xCRC 0xCRC

11.2.1 2. Access to real-time information

Measurement and alarm information from the detectors is listed in the transfer table from address 2000 to 65535. The sensor measurements are available at addresses 2001 to 2264, the sensor statuses are available at addresses 2301 to 2564 (alarm 1, alarm 2, etc.).

Example

Access to measurements from the sensor located at line 2 and address 32 of unit n° 2.

A. Determination of the sensor address: 1

B. Structure of the *Modbus* request:

- Slave number for the unit 02 = 0x02
- Operating type (03 = read) 03 = 0x03
- Address of the 1st word 2000+1 = 0x07D1
- Number of words to read 01 = 0x0001
- CRC

Thread: 0x02 0x03 0x07 0xD1 0x00 0x01 0xCRC 0xCRC

Example

Access the status of the sensor located at analog input 1 of unit n° 2.

A. Calculation of the table index: $256 + 1 = 257$

B. Request script:

- Slave number for the unit 02 = 0x02
- Operating type (03 = read) 03 = 0x03
- Address of the 1st word $2300 + 257 = 0x09FD$
- Number of words to read 01 = 0x0001
- CRC

Thread: 0x01 0x03 0x09 0xFD 0x00 0x01 0xCRC 0xCRC

11.3 Address Table

11.3.1 Supervision of the *MX 16* sensors

All reading requests for the *Modbus* are done *via* function 3. The cartography is shown below:

0	Slave address management	From addresses 0 to 1999, the <i>Modbus</i> request address serves to select a slave. The response consists of a data structure corresponding to
---	--------------------------	---

MX 16

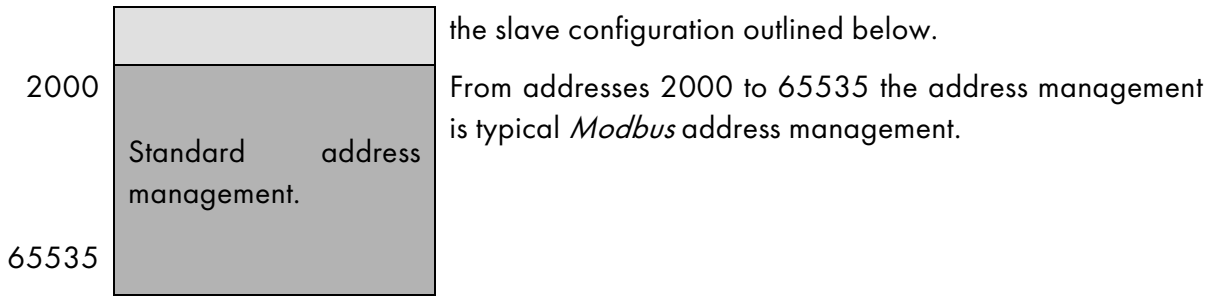

11.3.2 Configuring sensors

Downloading the configuration

The *MX 16* uses 1 external addresses (line #1 channel #1 and 257 analog channels for which the addresses are located from 257 to 258).

With the automated system, it is possible to send 1 *Modbus* requests, where the address field is numbered at 1 then at 257 in order to download the configuration of each sensor into the internal memory.

As a result of the operating functionality, it is only possible to repatriate the data of a single sensor for interrogation.

If a sensor is stated at the address mentioned, the *MX 16* sends the number of data words requested; always from data #1: NAME OF ANALOG SENSOR, at data #x.

If there is no information at the address mentioned, the *MX 16* sends back 0.

1

Line 1 Sensor 1
Analog line #1

257

Sensor addresses

Address	SENSORS [64 + 2]	Nb bytes	Data type														
1	Com sensor	2 X 16	Unicode text (16 bits) 16 characters including the final /0.														
17	Status	2	Start / Stop: if in operation, variable = 1. If stopped, variable = 0.														
18	Gas name	2 x 20	Unicode text (16 bits) 20 characters including the final /0.														
38	Range	2	Value The range is from 1 to 5000. Range X 10 display format. The display format is given in another box.														
39	Display format	2	Coded value.														
40	Unit	2 X 5	Unicode text (16 bits) 5 characters including the final /0.														
45	Abbreviated gas name	2 x 6	Unicode text (16 bits) 6 characters including the final /0. CAUTION, if the first 2 letters = O2: special treatment.														
51	Zone	2	Value	1 to 8													
52	Instantaneous alarm threshold 1	2	Value	-999 to 9999 (real value to be multiplied like the range)													
53	Instantaneous alarm threshold 2	2	Value	-999 to 9999 (real value to be multiplied like the range)													
54	Not used	2	Value	0													
55	Not used	2	Value	0													
56	Not used	2	Value	0													
57	Not used	2	Value	0													
58	Underscale threshold	2	Value	-999 to 9999 (real value to be multiplied like the range)													
59	Overscale threshold	2	Value	-999 to 9999 (real value to be multiplied like the range)													
60	Default low threshold	2	Value	-999 to 9999 (real value to be multiplied like the range)													
61	Out of range threshold	2	Value	-999 to 9999 (real value to be multiplied like the range)													
62	Not used	2	Value														
63	Not used	2	Value..														
64	Not used	2	Value														
65	Hysteresis	2	Value	Caution, max = 5% of the range. Always use a positive value and not a percentage.													
66	Alarm active?	2	Configuration per bit	All active inst: 1, 2.		bit6	bit5	bit4	bit3	bit2	bit1	bit0					

MX 16

ANALOG AND DIGITAL CONTROLLER USER MANUAL

				0 = inactive 1 = active					Alarm avg 2	Alarm avg 1		Alarm inst 2	Alarm inst 1
67	Acknowl alarm? (Auto/manu) Verification	2	Configuration per bit	Manual acknowl Al 1, 2, 3, verification	bit7	bit6	bit5	bit4	bit3	bit2	bit1	bit0	
				1 = Manual acknowl and 0 = Automatic Acknowl. When the <i>Verification</i> is at 1, the <i>Verification</i> alarm, once activated, is deactivated by stopping the sensor. If the acknowledgment is manual, alarms 1, 2 or 3, once activated, are deactivated using the acknowl button + measurement < alarm.	1 = verification	put 0 mandatory	put 0 mandatory	put 1 mandatory	put 0 mandatory		1=A1/2 ackmanu	1=A1/1 ackmanu	
68	Increasing or decreasing alarm?	2	Configuration per bit	Al 1, 2, 3 instantaneous or average increasing or decreasing									
				1: increasing 0: decreasing				Alarm 2	Alarm 1		Alarm 2	Alarm 1	

Table of registers (below)

11.3.3 Acquisitions retrieved cyclically

Real address	SENSOR MEASUREMENTS [256 + 8]	Nb bytes	Data type
If digital Start: 2001 end : 2064 If analog Start: 2257 end : 2258	Sensor measurement	2	Table with 66 signed integer of 16 bits where the measurements are listed at their address. The measurement being whole, the automatic system uses the Display format field to determine where to position the comma.

Real address	ALARMS [256 + 8]	Nb bytes	Data type
If digital Start: 2301 end : 2364 If analog Start: 2557 end : 2558	Table of activated alarms	2	Table with 66 signed integers of 16 bits where the alarms bits are listed at their address. ALARM_1 (bit 0) ALARM_2 (bit 1) bit 2 not in use UNDERSCALE (bit 3) OVERSCALE (bit 4) AL_DEFAULT (bit 5) AL_OUT_OF_RANGE (bit 6) L_VERIFICATION (bit 7) Bits 8 to 16 not in use

Real address	INFO	Nb bytes	Data type
2600	CRC32 of the general configuration	2	32 most significant bits option. Note: CRC32 of the entire configuration except the relays (from 0x78000 to 0x7AFFC). If different, re-upload the configuration.
2601		2	32 least significant bits option.
2602	Second counter	2	32 most significant bits option; Note: this counter increases every second and verifies that the unit is active.
2603		2	32 least significant bits option.

MX 16

ANALOG AND DIGITAL CONTROLLER
USER MANUAL

12 Specific conditions of use and Functional Safety

12.1 Specific Conditions of Use

The safety function of the *MX 16* is the processing of the signal of the detectors linked to its input. As soon as a measurement reaches a programmed threshold, an audio and visual alarm goes off. Simultaneously, the possible corresponding alarm relay(s) is (are) activated, commanding additional internal or external actions set forth by the user.

In case of system failure, the internal fault relay opens to indicate a fault status (see Figure 7: Internal view).

The fault relay switches over one of the following events:

- Internal error
- Loss of power
- Detector fault
- Connection failure between a measuring line and the detector

The security function is not ensured for 30 seconds after the initialization phase of the installation (power on, reset, restart after configuration change) then during the programmable stabilization time from 30 to 500 seconds.

It is imperative to connect the fault relay and to process this information in any installation.

Once per year minimum, it is suggested to voluntarily trigger a fault on one of the measuring lines, by disconnecting a detector, for example, and checking the proper switching of the fault relay.

12.2 Specific instructions for the prevention of explosions

- It is essential to refer to the instructions of use and commissioning of the gas detector that is connected to the controller.
- *MX 16* controller is digitally compatible with OLCT 10N, OLCT 80, OLCT 710, iTrans2, 700 series and Meridian gas detectors.

- In the event the user connects a non-TELEDYNE OLDHAM SIMTRONICS brand detector to the *MX 16* controller, the user must ensure that the detector is compatible with the input characteristics of the controller, so that the information delivered by the detector will be properly interpreted (see transfer curve on the following page). In addition, the controller must provide sufficient supply voltage, taking into account voltage drops in the cable.
- Highest alarm set point for flammable gases shall not exceed 60% LEL and shall be of a latching type.
- In normal operation mode and without any time delay that the user could have programmed, *MX 16* response time is less than 2 seconds regardless of the number of inputs/outputs.
- Time delay and relay operation settings (see voir Alarm Thresholds and Relays, page 16) is the responsibility of the user.
- Over-range (flammable gases)

As soon as gas concentration exceeds 100% LEL, *MX 16* stores the over-range condition and displays *>100% LEL*. The concerned channel goes into alarm and fault condition and OVS (*OVERSCALE*) and FAULT (*FAULT*) visual indicators are lit.



Alarm reset is manual and under the responsibility of the user who must follow the site-specific safety guidelines. Over-range condition can only be deactivated by switching off the detector via the maintenance menu providing the gas concentration is below the alarm threshold.

- *MX 16* controller must not be exposed to mechanical vibrations and must be installed in a non-hazardous area.
- With respect to installation in explosive atmospheres, the electrical installation must comply with the regulation in force, in particular EN 60079-14 and EN 6079-17 standards (current editions) and, if necessary, additional requirements of domestic or national regulations that apply to the place of installation.

12.3 Connecting detectors other than *TELEDYNE OLDHAM SIMTRONICS* detectors to the *MX 16* controller

Any user wishing to use detector other than TELEDYNE OLDHAM SIMTRONICS detectors must ensure that they are compatible with the controller, in order the complete installation to be considered as a safety device.

12.3.1 Transfer table

The following table shows the controller status depending on the detector analog signal output. In the event the user connects a non-*TELEDYNE OLDHAM SIMTRONICS* brand detector to the *MX 16* controller, the user must ensure that the detector is compatible with the input characteristics of the controller, so that the information delivered by the detector will be

properly interpreted. In addition, the controller must provide sufficient supply voltage, taking into account voltage drops in the cable.

Detector signal output	<i>MX 16</i> Status
0 to 2.4 mA	Fault
>2.4 to 21.6mA	Measurement
>21.6 mA	Over Range Fault

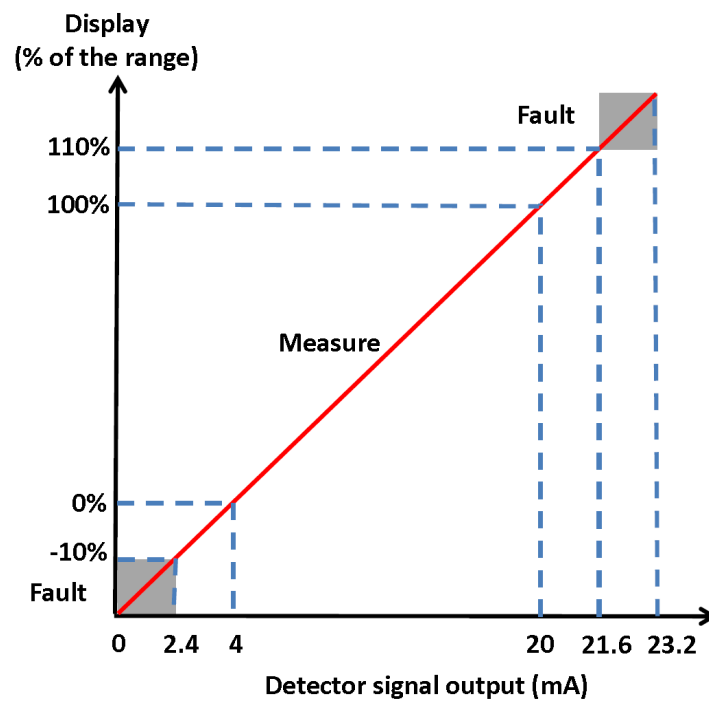



TELEDYNE
OLDHAM SIMTRONICS
Everywhereyoulook™



AMERICAS

14880 Skinner Rd

CYPRESS

TX 77429,

USA

Tel.: +1-713-559-9200

EMEA

Rue Orfila

Z.I. Est – CS 20417

62027 ARRAS Cedex,

FRANCE

Tel.: +33 (0)3 21 60 80 80

ASIA PACIFIC

Room 04, 9th Floor, 275

Ruiping Road, Xuhui District

SHANGHAI

CHINA

Tel.: +86-134-8229-5057

www.teledynegasandflamedetection.com



© 2021 Teledyne Oldham Simtronics. All right reserved.

NPM16EN Revision A.O. / April 2021