



TELEDYNE
OLDHAM SIMTRONICS
Everywhereyoulook™

USER MANUAL

SURVEYOR 4B

SINGLE CHANNEL CONTROLLER



SURVEYOR 4B

SINGLE CHANNEL CONTROLLER
USER MANUAL

User Manuals in other languages are available on
Website <https://teledynegasandflamedetection.com>



Copyright © April 2021 by TELEDYNE OLDHAM SIMTRONICS S.A.S.

All rights reserved. No reproduction of all or part of this document, in any form, is permitted without the written consent of TELEDYNE OLDHAM SIMTRONICS S.A.S.

All of the information that is provided in this document is accurate to the best of our knowledge.

As a result of continuous research and development, the specifications of this product may be changed without prior notice.

TELEDYNE OLDHAM SIMTRONICS S.A.S.

Rue Orfila

Z.I. Est – CS 20417

62027 ARRAS Cedex

Table of Contents

1	General	1
1.1	User Manual.....	1
1.2	Safety Instructions.....	2
1.3	Important Information	2
1.4	Liability Limits	2
1.5	Warranty.....	2
2	General introduction	3
3	Mounting and Wiring of the SURVEYOR 4B	5
3.1	Alternative power supply	6
3.2	DC power supply	6
3.3	Explosimetric detectors.....	6
3.4	External components.....	7
3.5	Examples of installation.....	8
4	Operating instructions	11
4.1	Switching on	11
4.2	Switching off	11
4.3	Alarms	12
4.4	Adjustments	12
5	Technical specifications	17
6	Disposal	19
7	Main Part Numbers	21
8	Maintenance	23
8.1	Cleaning	23
8.2	Fuse replacement	23
9	Certificate of Compliance	25

SURVEYOR 4B

SINGLE CHANNEL CONTROLLER
USER MANUAL



1 General

1.1 User Manual

The instructions given in this manual must be read thoroughly before installation and start-up, particularly those concerning the points related to the safety of the end-user. This user manual must be made available to every person involved in the activation, use, maintenance, and repair of the unit.







The information, technical data, and diagrams contained in this manual are based on the information that is available at a given time. In case of doubt, contact *TELEDYNE OLDHAM SIMTRONICS* for additional information.

The aim of this manual is to supply simple and accurate information to the user. *TELEDYNE OLDHAM SIMTRONICS* cannot be held liable for any misinterpretations in the reading of this manual. In spite of our efforts to produce an error-free manual, it may nonetheless contain some unintentional technical inaccuracies.

In the client's interest, *TELEDYNE OLDHAM SIMTRONICS* reserves the right to modify the technical characteristics of its equipment to increase their performance without prior notice.

The present instructions and their content are the inalienable property of *TELEDYNE OLDHAM SIMTRONICS*.

Symbols used

Icon	Significance
	This symbol indicates useful additional information.
	This symbol indicates: Earth ground connection.
	This symbol indicates: DC voltage
	This symbol indicates: AC voltage
	This symbol denotes: Attention! In the present mode of use, failure to adhere to the instructions preceded by this symbol can result in a risk of electric shock and/or death.
	This symbol indicates: You must refer to the instructions.
	European Union (and EEA) only. This symbol indicates that this product must not be discarded with household waste, as per the EEA directive (2002/96/EC) and your own national regulations. This product must be disposed of at a collection point that is reserved for this purpose, for example, an official site for the collection of electrical and electronic equipment (EEE) in view of their recycling, or a point of exchange for authorized products that is accessible when you acquire a new product of the same type.

1.2 Safety Instructions

Labels intended to remind you of the principal precautions of use have been placed on the unit in the form of pictograms. These labels are considered an integral part of the unit. If a label falls off or becomes illegible, please ensure it is replaced. The significance of the labels is detailed below.



The installation and electrical connections must be carried out by qualified personnel according to the instructions of the manufacturer and according to the local or national regulations applicable to the place of installation.

Some voltages can cause serious injury or even death (risk of electric shock), it is advisable to install the equipment and to carry out the wiring before powering up and to protect yourself with appropriate Personal Protective Equipment.

Cables with an operating temperature of 60°C minimum (140 °F) must be used because the temperature inside the controller can reach 65°C (149 °F).

1.3 Important Information

The modification of the material and the use of parts of an unspecified origin shall entail the cancellation of any form of warranty.

The use of the unit has been projected for the applications specified in the technical characteristics. Exceeding the indicated values cannot in any case be authorized.

1.4 Liability Limits

Neither *TELEDYNE OLDHAM SIMTRONICS* nor any other associated company under any circumstances can be held liable for any damage, including, without limitations, damages for loss or interruption of manufacture, loss of information, defect of the *Surveyor 4B* controller, injuries, loss of time, financial or material loss, or any direct or indirect consequence of loss occurring in the context of the use or impossibility of use of the product, even in the event that *TELEDYNE OLDHAM SIMTRONICS* has been informed of such damage.

1.5 Warranty

Under normal conditions of use and on return to the factory, parts and workmanship carry a one year warranty, excluding consumables such as backup power supplies, audio and visible alarms, etc.

2 General introduction

This controller is intended for the continuous measurement and control of the gases present in the atmosphere.

The *Surveyor 4B* (or *SV 4B*) is intended for indoor use only and shall be installed in premises without explosive atmospheres.

The central controller is intended for use in areas that meet the Class II requirements for overvoltage and degree of pollution 2. *Surveyor 4B* is Class II equipment.

The device has been designed and tested for class II insulation (between dangerous voltages and SELV¹).

Surveyor 4B is equipped with a small "NORMAL" box (58 x 105 x 90 mm). It can be snap-fastened onto a standard symmetrical DIN rail and should **imperatively** be integrated in a closed electrical equipment cabinet with protection class IP20, providing fire containment according to IEC 60695-2-11 and in accordance with the electrical standards of the country of installation.

The components used in operation are located on the front of the appliance:

- adjustments and tests on the top (Item 1, Figure 1),
- indicator lights on the FRONT face (Item 2, Figure 1),
- connections at the bottom (Item 3, Figure 1).

¹ SELV: Safety Extra Low Voltage

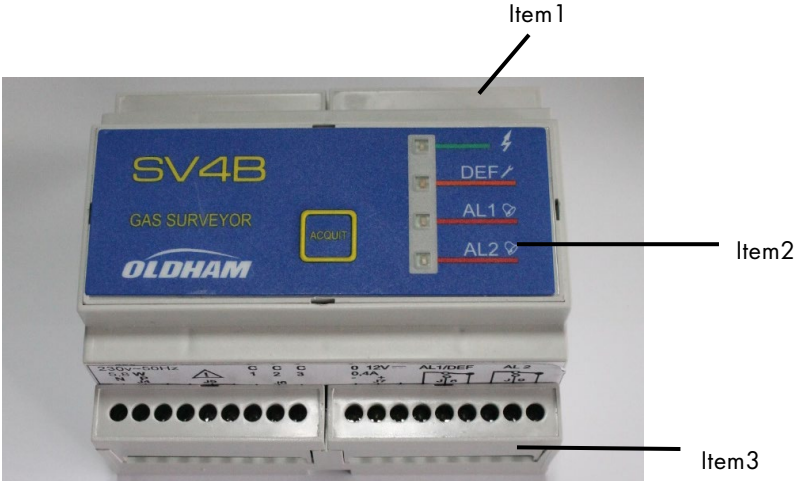

Figure 1

3 **Mounting and Wiring of the *SURVEYOR 4B***



The *Surveyor 4B* appliance fitted on its symmetrical DIN rail must be installed in a closed electrical equipment cabinet.

A space of 100 mm is necessary around of the *Surveyor 4B*.

The *Surveyor 4B* should preferably be located in a monitored location (such as a guardhouse, control room or instrumentation room).



The *Surveyor 4B* does not have a start/stop switch.

Certain voltage levels are capable of causing serious injuries or even death. It is advised to install the material and cabling before applying live voltage.

Since an incorrect or poor installation may cause measurement errors or system failures, it is necessary to strictly follow all the instructions in this manual in order to guarantee the proper operation of the system.

Cables with an operating temperature of 60°C minimum (140 °F) must be used because the temperature inside the controller can reach 65°C (149 °F).

The electrical connections must be carried out by qualified personnel in compliance with the different directives in force in the country of installation.

The nature of the current and line voltage must be checked. The line voltage must match the voltage specified on the plate fitted on the *Surveyor 4B*. The voltage is configured in the factory.

The wires to be connected to the *Surveyor 4B* must have a minimum cross section of 1.5 mm².

The *Surveyor 4B* appliance can be supplied with either 230 Vac² or 12 Vcc³.

² from 207 to 253 Vac (@50hz)

³ from 11.5 to 14 Vdc

3.1 Alternative power supply

3.1.1 230 volt AC power supply

The *Surveyor 4B* must be protected on the upstream side by a two-pole earth leakage circuit breaker (1A) installed near the *Surveyor 4B* and is considered as main cut-off device.

The response curve must be of type D.

The mains power supply must be wired on the two points marked N (Neutral) and P (Phase) on the *Surveyor 4B* terminal block (see **Erreur ! Source du renvoi introuvable.**, Item 1).

The wires to be connected to the *Surveyor 4B* must have a minimum cross section of 1.5 mm²

3.2 DC power supply

3.2.1 12-volt power supply

The 12 volt power supply (SELV) can be connected to the points marked 0 and 12 V --- on the *Surveyor 4B* terminal block (see Figure 2, Item2).

The *Surveyor 4B* must be protected on the upstream side by a fuse (630mA) with time-delay.

The cable must have a minimum cross section of 1.5 mm².

Power consumption: 5.8 W max. (detector connected).

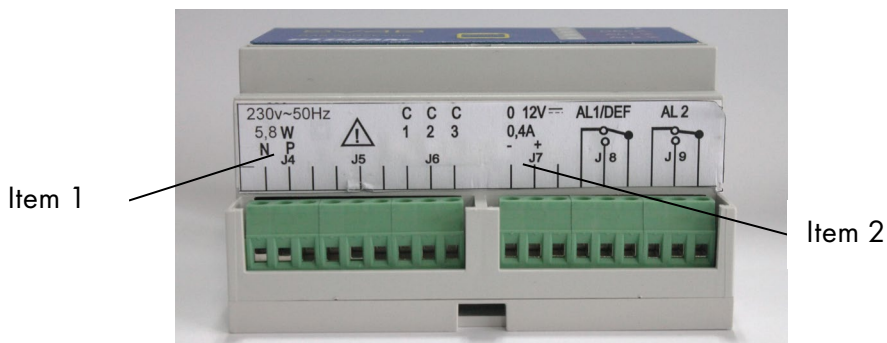
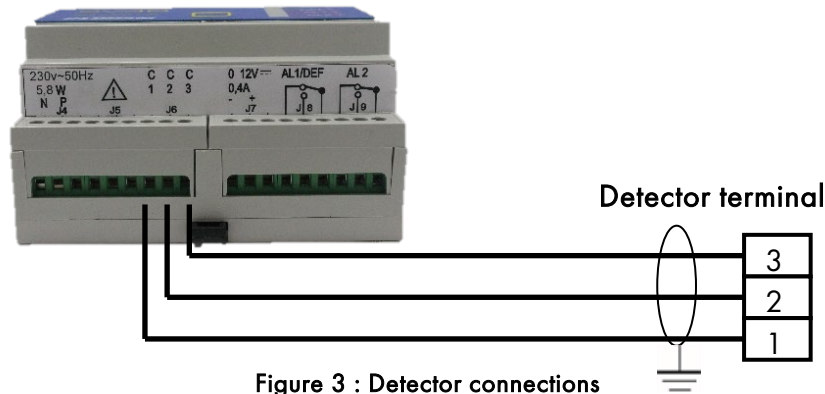

Figure 2 : power supply connections

3.3 Explosimetric detectors

- Only explosimetric detectors of the "bridge" type can be connected to the SV 4B.
- *Surveyor 4B* and the detector are connected (SELV) together by a shielded cable with three active conductors. The shielded cable is to be connected to the earth to EMC constraints at one end only.
- Terminals C1, C2 and C3 of *Surveyor 4B* and the detector are to be connected in opposite mode (Figure 3).
- The maximum loop resistance is 1.4 ohms.

For example: the maximum distance between *Surveyor 4B* and the detector will be 40 m with conductors with a cross section of 1.5 mm².



3.4 External components

Surveyor 4B is equipped with the following two relays (see 5):

- Relay 1 (REL 1), which is in mode, corresponds to the first gas alarm threshold and to the "FAULT" alarm. This relay is equipped with SPDT contacts available on the SV 4B terminal block (Item 3, Figure 4).
- Relay 2 (REL 2), which is "negative safety" mode, corresponds to the second gas threshold only. This relay is also equipped with SPDT contacts available on the SV 4B terminal block (item 4, Figure 4).
- These both relays could be configured in positive security.

The cable must have a minimum cross section of 1.5 mm².

N.B.: The relay contacts are dry contacts, corresponding to the appliance without power supply.

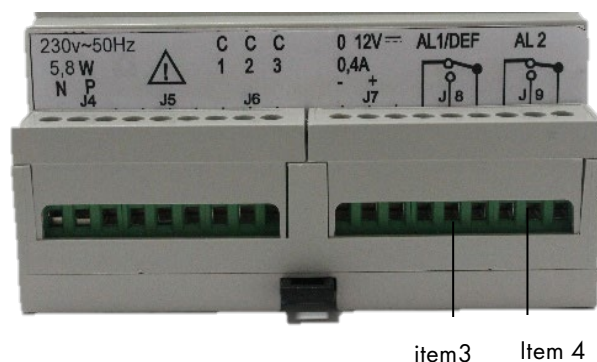

Figure 4: relays terminals



The maximum current through the relay contacts will be 2 A and the maximum voltage will be 250 Vac or 30 Vdc.

3.5 Examples of installation

3.5.1 Example of installation set up of a SV 4B with TWO OLC 10 TWIN detectors

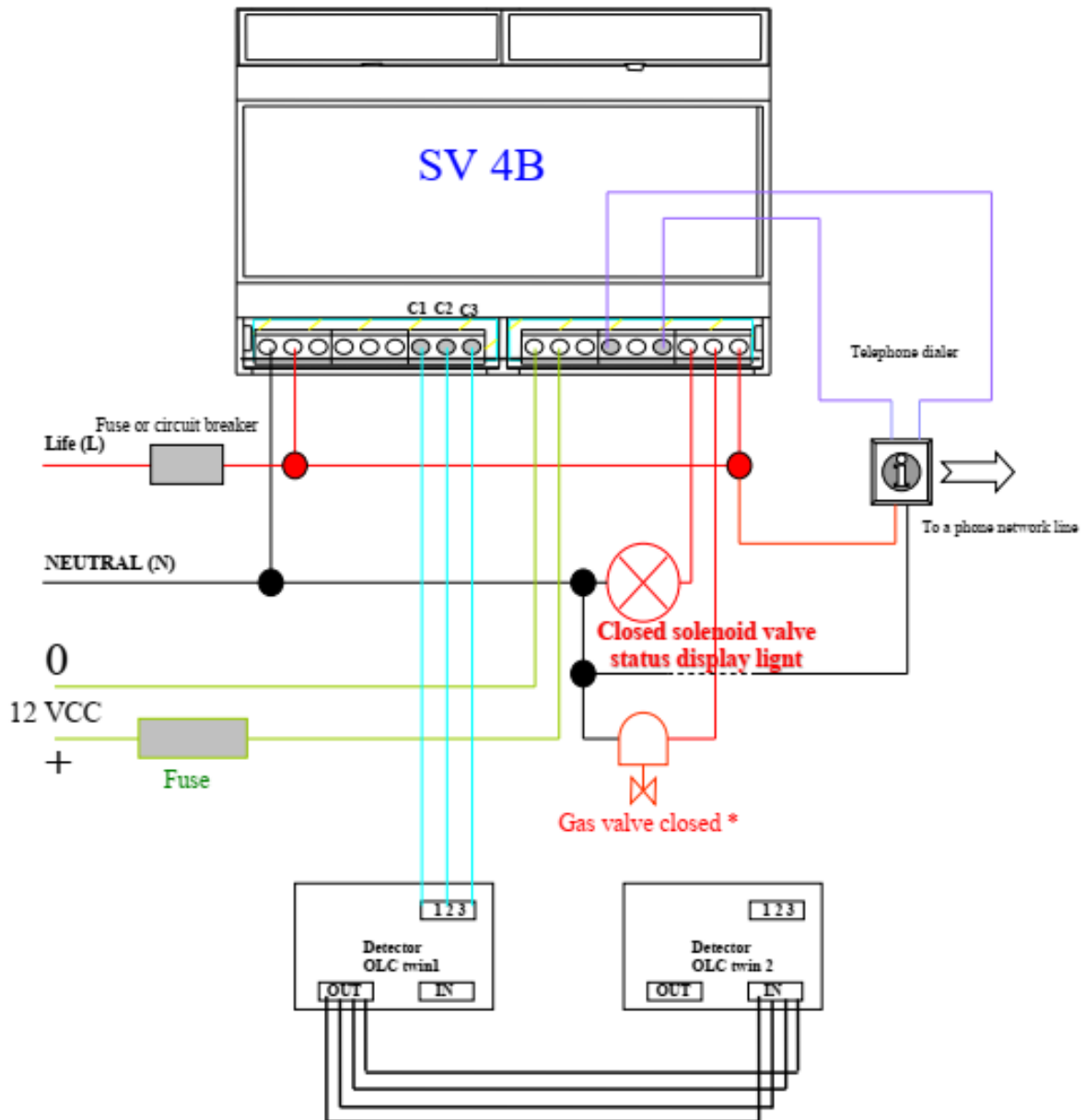

Figure 5 : Example of installation set up of a SV 4B with TWO OLC 10 TWIN detectors

* Breaking capacity of rating relays switch contact: 2A / 250Vca - 30Vdc

3.5.2 Example of installation set up of a SV 4B with a single detector (OLC10 or OLC100)

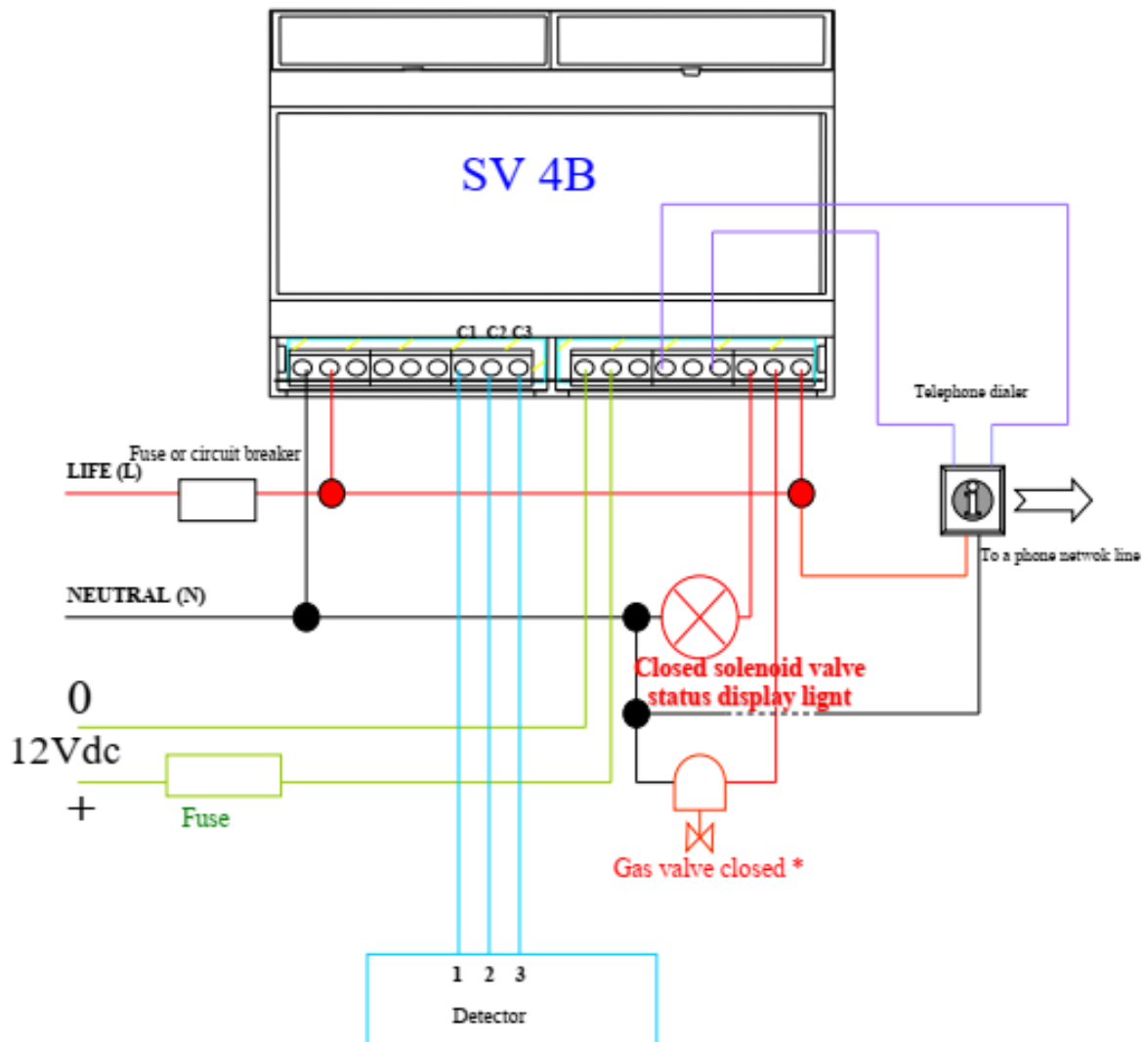

Figure 6 : Exemple d'installation d'un *Surveyor 4B* avec un capteur

* Breaking capacity of rating relays switch contact : 2A / 250Vca – 30Vcc

SURVEYOR 4B

SINGLE CHANNEL CONTROLLER
USER MANUAL



4 Operating instructions



The operations and adjustments described in this chapter must be performed by authorized personnel only as they can affect the appliance's reliability in detection.

Do not remove protective covers during operations.

Gas detectors are safety devices. TELEDYNE OLDHAM SIMTRONICS recommends the regular testing of fixed gas detection installations. This type of test consists of injecting the calibration gas into the detector at a sufficient concentration to activate the pre-set alarms. It is to be understood that this test is in no way a replacement for a detector calibration.

The frequency of gas tests depends on the industrial application where the detector is in use. Frequent inspections should be made in the months following the commissioning of the installation and should then become more widely spaced provided that no significant deviation is observed. If a detector should fail to react in contact with the gas, calibration is essential. The frequency of calibrations shall be appropriate according to the results of the tests (humidity, temperature, dust, etc.); however, it must not exceed one year.

The general manager should put safety procedures in place on-site. TELEDYNE OLDHAM SIMTRONICS cannot be held responsible for their enforcement.

4.1 Switching on

It is assumed that all the necessary connections have been made and that the whole installation complies with the standards currently in force.

As soon as the SV 4B is supplied with power, it is ready to use and the GREEN light-emitting diode lights up (rep 1, Figure 7).

Relay 1 is operated ("positive safety" position).

4.2 Switching off

Switching off the SV 4B will be done by means of the switching device placed nearby. (see chapter 230 volt AC power supply, page 6).

The power supply of the enslavement controlled via the relays of the SV 4B must be cut before any intervention.

4.3 Alarms

4.3.1 GAS alarm

The SV 4B has two adjustable GAS alarm thresholds but the second threshold (AL 2) must be twice the first (AL 1).

Therefore, the red light-emitting diodes "AL1" and "AL2" (rep 3, Figure 7) come on as soon as the alarm thresholds are exceeded (time delay of 7 seconds): LED flashing. The audio alarm (buzzer) is activated and the corresponding relays are tripped.

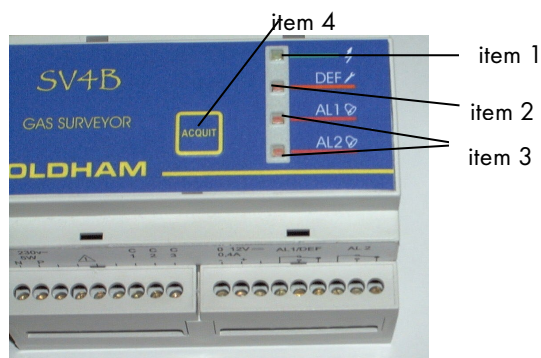

Figure 7

4.3.2 FAULT alarms

The SV 4B is equipped with a fault alarm (visual alarm (rep 2, Figure 7), audio alarm and relay 1) which is activated in the following cases:

- One or more wires of the telemetry line interrupted
- One or more wires of the telemetry line short-circuited or with excessive power consumption.

NB : The ALARM LEDs may also be activated depending on the circumstances of the interruption or the short circuit.

4.4 Adjustments

4.4.1 Adjusting the "gas alarm" thresholds

Using a "reference gas kit" (gas cylinder + pressure regulator, etc.), inject the reference gas with a content level higher than the first threshold desired. (For example, threshold 1 will be 20% LEL, so a minimum of 25% LEL should be injected).

Adjust the alarm potentiometer (rep 1,

) to trigger the first threshold (AL1): the red LED (AL1) flashes (for 7 seconds) and then remains on in steady mode, trip the corresponding alarm relay.

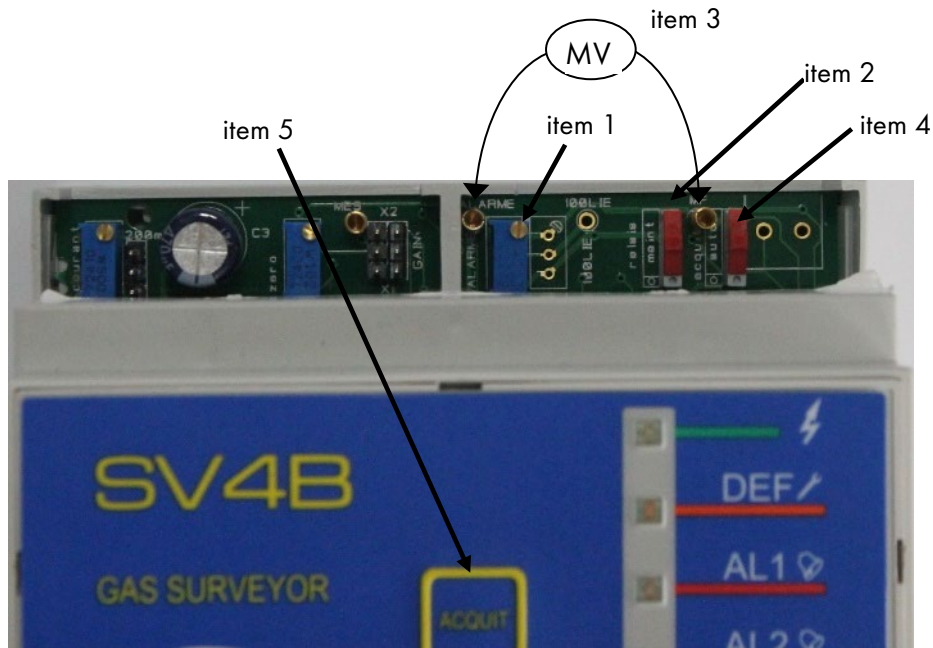
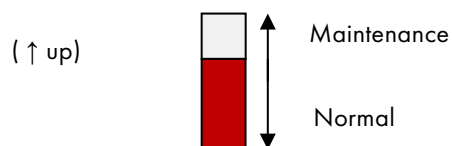

Figure 8

If you stop at this point, alarm 2 will be set to twice the level of alarm 1.

If you continue until alarm 2 is triggered: alarm 1 will be set to half the level of alarm 2.

If you wish to lock the alarm relays (inhibiting the relays) during these alarm threshold adjustments: set the maintenance switch to the high position (item 2, Figure 8).



When the adjustments have been made, do not forget to place the switch back in its normal position.

Terminal posts (item 3, Figure 8) are used to connect up a voltmeter for the reading of a signal (in mV) corresponding to the content level of the injected gas.

Then, using a rule of three, it is possible to calculate and adjust another signal (in mV) for an alarm threshold (potentiometer: item 1, Figure 8) corresponding to a different gas content level.

For example: when you inject 1% methane, you read 1,000 mV (for instance).

If you set the alarm potentiometer to read 1,500 mV, the alarm is triggered at 1.5% methane.

$$\text{Signal} = \frac{1000mV \times 1\%}{1000mV} = 1500mV$$

Or

$$\text{Threshold (\%)} = \frac{1\% \times 1500mV}{1000mV} = 1.5\%$$

4.4.2 Acknowledgement of gas alarms

A switch (item 4, Figure 8) is used to acknowledge gas alarms in manual mode or automatic mode.

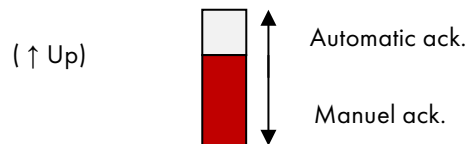

Manual mode: When a gas alarm is triggered, it must be cleared manually even if the content level has fallen to zero (or to below the threshold). This is done by pressing the Ack. key (item 5, Figure 8).



As long as there is a high enough concentration of gas to trigger an alarm, it is impossible to clear that alarm manually (with the Ack. button).

Automatic mode: When a gas alarm is triggered, it is cleared automatically as soon as the content level falls below the alarm threshold.

4.4.3 Adjusting the ZERO

Zero adjustment is carried out in case of cell change and at least once a year.

- Connect a voltmeter to the two terminal posts provided for that purpose (MF and MES), as shown below:
- Be sure to be in pure atmosphere (without gas) (If not, inject air)
- Adjust the ZERO (0 mV) with the potentiometer, item 1, Figure 9.

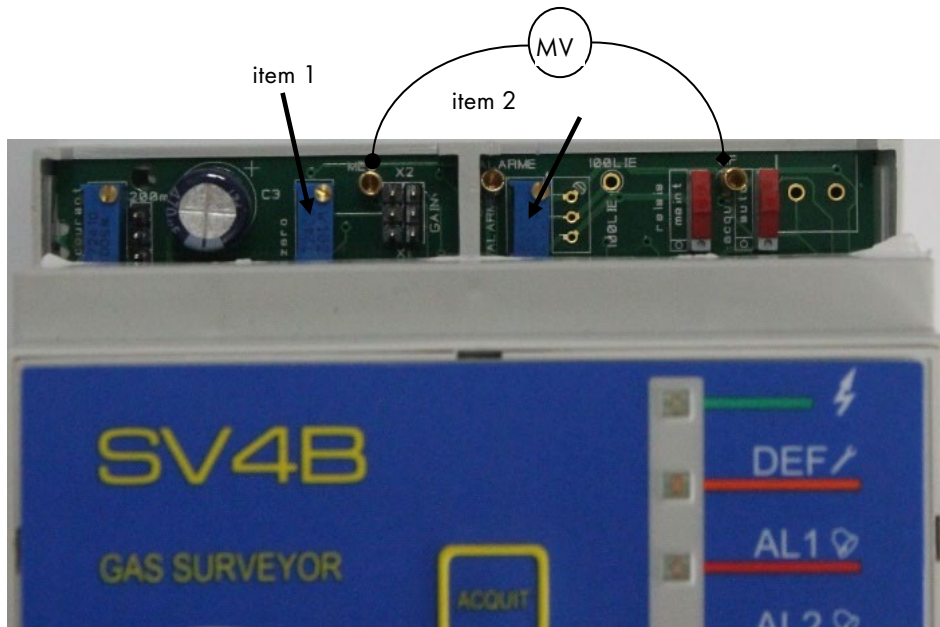
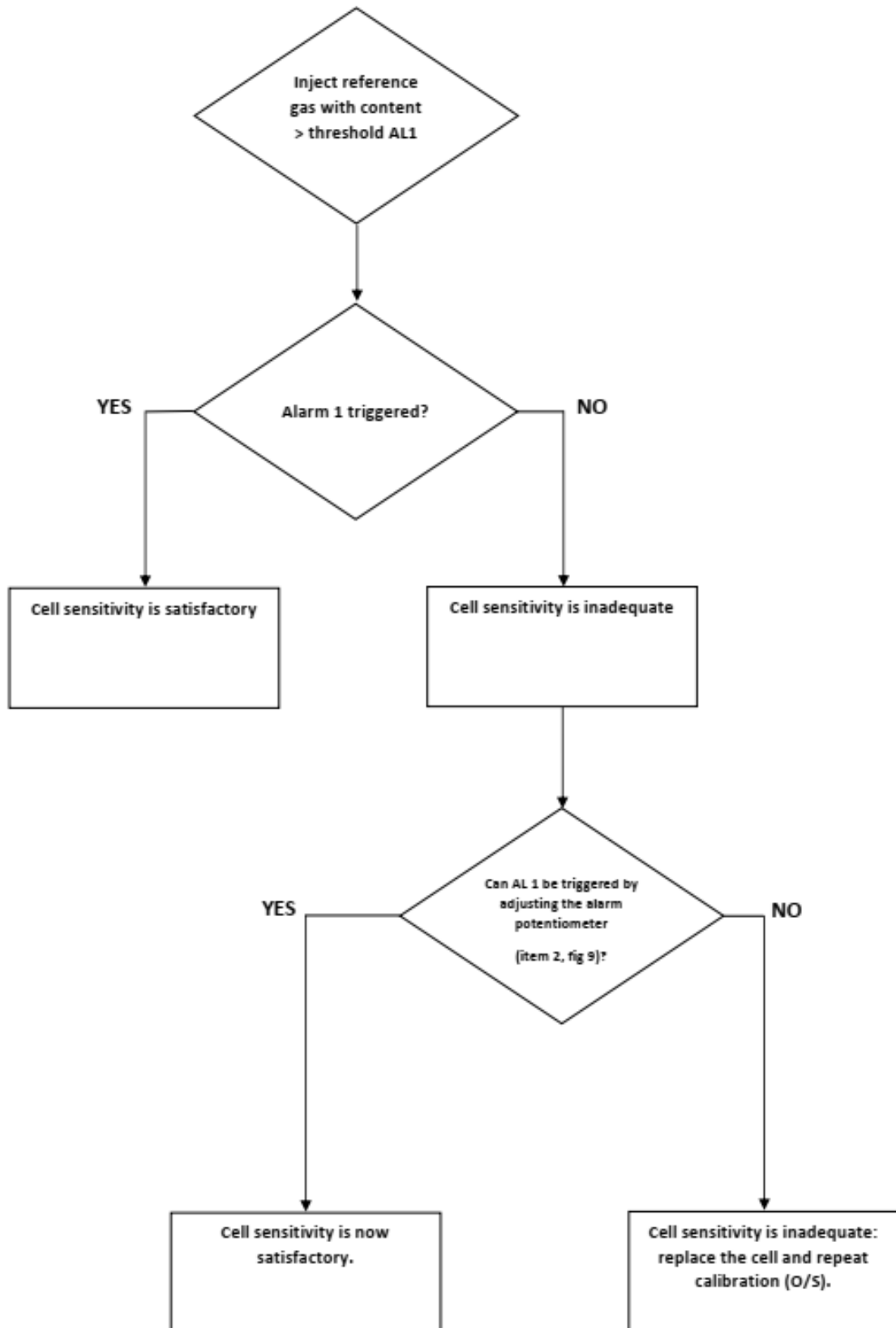

Figure 9

4.4.4 Checking the sensitivity

Sensitivity adjustment is carried out in case of cell change and at least once a year.

- Prepare the calibration kit and secure the gas input pipe to the detector.
- Adjust the flow rate of the reference gas to 60 l/h before injecting. The gas concentration will be greater than at least the first alarm threshold.
- Allow to stabilize for at least 30 seconds.
- Check that the alarm or alarms are triggered (as applicable) and carry out the following procedure.



5 Technical specifications

Manufacturer	TELEDYNE OLDHAM SIMTRONICS
Type	SURVEYOR 4 B
Function	Control station for explosive gas detectors
Capacity	1 measurement channel 1 detector type CEX 300 or OLC10/100 or 2 OLC 10Twin detectors
Measurement	
<i>Measurement</i>	Continuous
<i>Display unit</i>	None
Visual alarms	Failure: yellow Gas, 1st threshold: red Gas, 2nd threshold: red
Audio alarm	Integrated
Alarm Acknowledgement	Manual ou automatic
Electric power supplies	
<i>Alternative</i>	230 VCA (207 à 253 V) – 50Hz Accepts mains voltage fluctuations up to +/- 10% of nominal voltage.
<i>Continue</i>	Accepts temporary Class II surges occurring on the power supply. The degree of pollution is level 2. 12 VCC (11.5 à 14 V) SELV
Power consumption	5.8 W (detector connected) @230Vac 0.4A (detector connected) @12 Vdc
Electrical protection	Fuse
Relays	
<i>Relay 1</i>	Common to gas (alarm 1) and fault
<i>Relay 2</i>	Gas alarm 2
Contact	SPDT, relay 1 (positive safety) SPDT, relay 2

SURVEYOR 4B

SINGLE CHANNEL CONTROLLER
USER MANUAL

Max. breaking capacity	2A sous 250Vca. Accepts temporary Class II surges 2A sous 30Vcc SELV
Measuring line	SELV
<i>Cable</i>	3 conductors
<i>Maximum line length</i>	40 m (with conductor 1.5 mm ²)
<i>Maximum loop resistance</i>	1.4 ohms
Mounting	On symmetrical DIN rail and into a closed cabinet
Miscellaneous	
<i>Technology</i>	SMC (surface mounted component)
<i>Mains visual indicator</i>	Green LED
<i>Housing</i>	NORYL
<i>Warranty</i>	1 year
Dimensions	58 x 105 x 90 mm
Weight	0.360 kg
Cable inlets/outlets	Screw type terminal block
Ingress Protection	IP 20
Mechanical protection	IK 08
Operating conditions	
<i>Ambient temperature</i>	+ 10 °C to + 45 °C
<i>Relative humidity</i>	5 % to 95 % non-condensed
<i>Altitude</i>	≤2000m

6 Disposal

Concerning the conservation, of the protection and the improvement of the quality of the environment, as well as for the protection of the health of the persons and the careful and rational use of natural resources, SV 4B has to be the object of a selective collection for the electronic equipments and cannot be scrapped with the normal domestic waste. The user thus has the obligation to separate the SV 4B of the other waste so as to guarantee that it is recycled in a sure way at the environmental level. For more details of the existing sites of collection, contact the local administration or the distributor of this product.



SURVEYOR 4B

SINGLE CHANNEL CONTROLLER
USER MANUAL



7 Main Part Numbers

Désignation	Reference	
<i>Surveyor 4B</i> controller for 340mA wheatstone bridge sensor	6 514 807	
Fuse 5x20 - T125 mA 250 V	6 154 701	

SURVEYOR 4B

SINGLE CHANNEL CONTROLLER
USER MANUAL



8 Maintenance

8.1 Cleaning

Do not use alcohol- or ammonia-based liquids to clean the central controller. If necessary, clean the exterior of the enclosure with a damp cloth.

8.2 Fuse replacement

8.2.1 Replacing the fuse

Some voltages can cause serious injury or death (risk of electric shock), switch off the SV 4B by means of the cut-off device placed nearby (see section Alternative power supply, page 6) before any electrical maintenance operation. It is also advisable to protect yourself with appropriate Personal Protective Equipment.

The power of devices controlled via the relay of the SV 4B must be cut before any intervention.

The fuse (Figure 10, item 1) must be replaced by qualified personnel only.

The fuse is, and must be, in compliance with CEI 60127, with time-delay, low breaking capacity and a voltage of 250 V ~. Please see Chapter 7

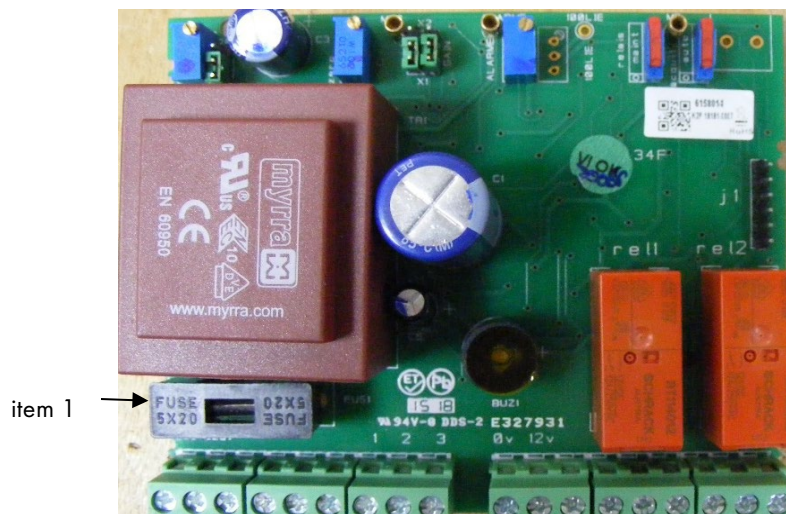

Figure 10



TELEDYNE OLDHAM SIMTRONICS does not allow any other repairs than those listed here above. It is mandatory that spare parts must be guaranteed original TELEDYNE OLDHAM SIMTRONICS parts as, otherwise, the reliability of the equipment could be adversely affected.

SURVEYOR 4B

SINGLE CHANNEL CONTROLLER
USER MANUAL



9 Certificate of Compliance

The document hereafter (1 page) reproduces the EU declaration of conformity.



TELEDYNE
OLDHAM SIMTRONICS
Everywhereyoulook™

**DECLARATION UE DE
CONFORMITÉ**

**EU CONFORMITY
DECLARATION**

Réf : UE_SV4B_rev C.1.doc

Nous,
We,

Teledyne Oldham Simtronics S.A.S., ZI Est, 62000 Arras France



Déclarons, sous notre seule responsabilité, que le matériel suivant :
Declare, under our sole responsibility that the following equipment :

Centrale de détection de gaz type Surveyor 4B
Surveyor 4B Gas Controller



Est conçu et fabriqué en conformité avec les Directives et normes applicables suivantes :
Is designed and manufactured in compliance with the following applicable Directives and standards:

I) Directive Européenne CEM 2014/30/UE du 26/02/14: Compatibilité Electromagnétique
The European Directive EMC 2014/30/UE dated from 26/02/14: Electromagnetic Compatibility

Normes harmonisées appliquées :
Harmonised applied Standards

EN 50270:2015 for type 1&2

II) Directive Européenne DBT 2014/35/UE du 26/02/14: Basse Tension
The European Directive LVD 2014/35/UE dated from 26/02/14: Low Voltage

Normes harmonisées appliquées:
Harmonised applied Standard

EN 61010-1:2010



Ce matériel ne doit être utilisé qu'à ce pour quoi il a été conçu et doit être installé en conformité avec les règles applicables et suivant les recommandations du fabricant.
This equipment shall be used for the purpose for which it has been designed and be installed in accordance with relevant standards and with manufacturer's recommendations.

A Arras, le 20/05/2020 / Arras, May 5th, 2020

Teledyne Oldham Simtronics S.A.S.
Z.I. EST - C.S. 20417
62027 ARRAS Cedex – FRANCE
Tel. : +33(0)3 21 60 80 80
www.teledyneGFD.com

AM. Dassonville
Certification Responsible

Dass

Page 1 | 1



TELEDYNE
OLDHAM SIMTRONICS
Everywhereyoulook™



AMERICAS

14880 Skinner Rd
CYPRESS
TX 77429,
USA
Tel.: +1-713-559-9200

EMEA

Rue Orfila
Z.I. Est – CS 20417
62027 ARRAS Cedex,
FRANCE
Tel.: +33 (0)3 21 60 80 80

ASIA PACIFIC

Room 04, 9th Floor, 275
Ruiping Road, Xuhui District
SHANGHAI
CHINA
Tel.: +86-134-8229-5057

www.teledynegasandflamedetection.com



© 2021 TELEDYNE OLDHAM SIMTRONICS. All right reserved.
NPS4BGB Revision F.0 / April 2021