

PRESSURE AND VACUUM SWITCHES

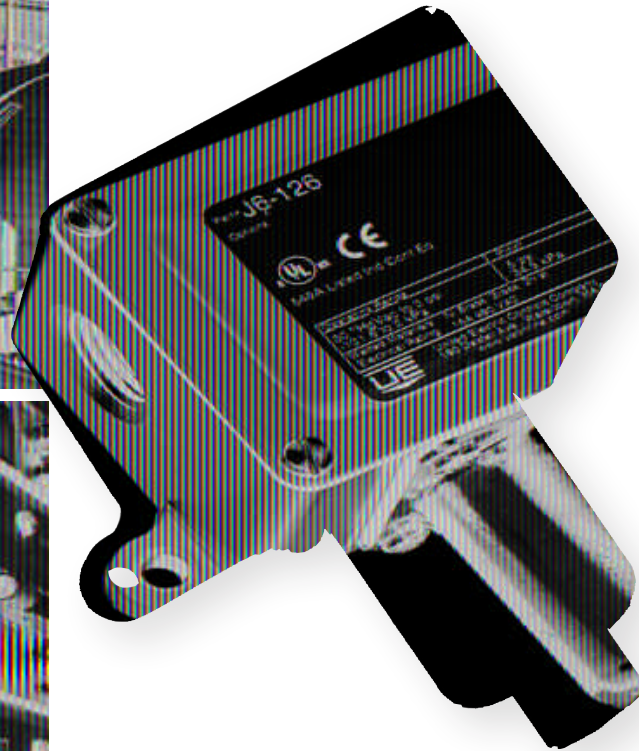

FEATURES

- Gasketed, Die Cast Aluminum Enclosure with Epoxy Coating
- SPDT Switch Output
- Adjustable Deadband Option
- Sealed, Isolated Metal Bellows Sensors
- Adjustable Pressure Ranges: 30 "Hg Vac to 6000 psi (-1 to 414 bar)

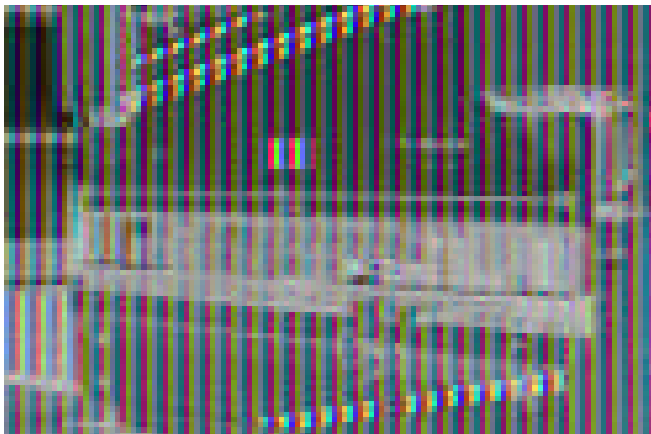
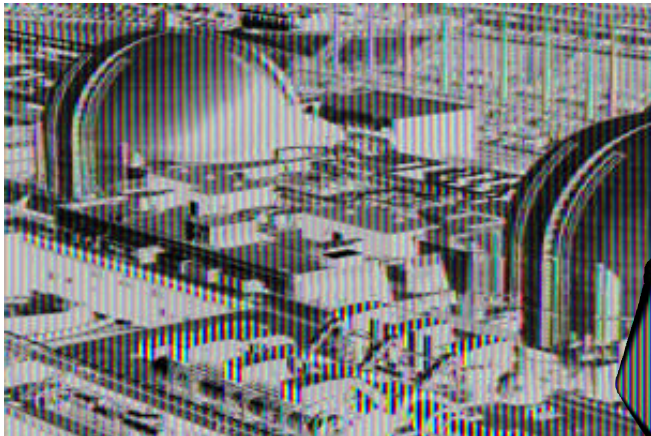

## OVERVIEW

The J6 is a reliable, sensitive pressure switch, originally designed for instrument air applications in process plants. Its compact design and combination of set-point sensitivity and narrow or optional adjustable deadband, offers cost-saving solutions for a variety of applications.

The J6 is ideally suited for a wide range of industrial processes such as alarm/shutdown and low/high service pressures. OEMs also utilize the J6 in machinery and equipment for threshold protection.

## FEATURES

- UL listed and cUL certified
- Optional ATEX or GOST intrinsic safety compliance
- Designed to meet Enclosure Type 4X
- SPDT switch output
- Adjustable deadband option for precise on-off control
- Brass or welded stainless steel bellows sensors
- External manual reset option

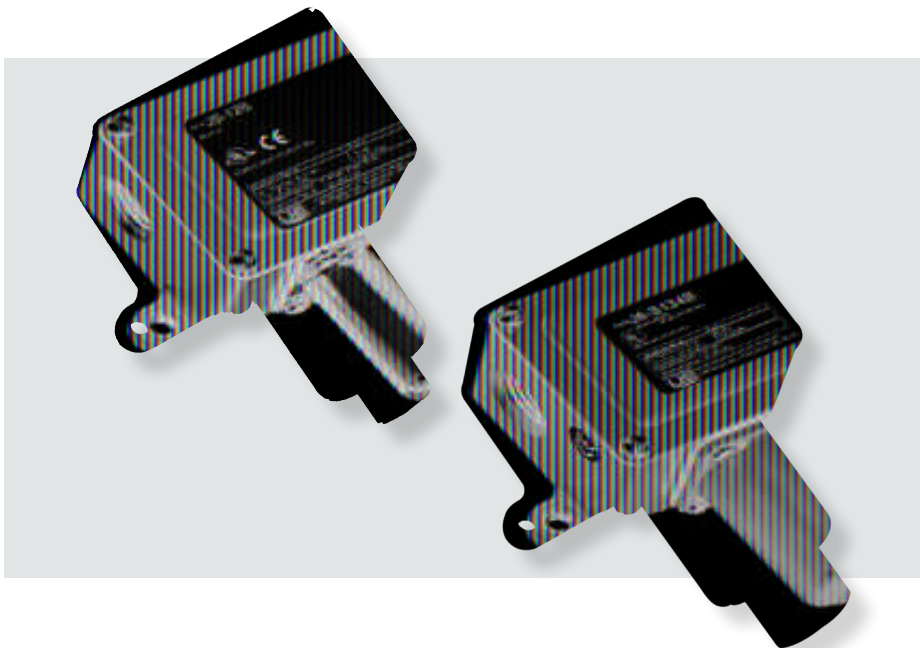

**SPECIFICATIONS**

<b>STORAGE TEMPERATURE</b>	-65° to 160°F (-54 to 71°C)
<b>AMBIENT TEMPERATURE LIMITS</b>	-40° to 160°F (-40 to 71°C); set point typically shifts less than 1% of range for a 50°F (28°C) ambient temperature change
<b>SET POINT REPEATABILITY</b>	Models S126B-S164B, 126-364, 680: ± 1% of adjustable range; models 610-614: ± 1.5% of adjustable range
<b>SHOCK</b>	Set point repeats after 15 G, 10 millisecond duration
<b>VIBRATION</b>	Set point repeats after 2.5 G, 5-500 Hz
<b>ENCLOSURE</b>	Die cast aluminum, epoxy powder coated, gasketed; captive cover screws
<b>ENCLOSURE CLASSIFICATION</b>	Designed to meet Enclosure Type 4X requirements
<b>SWITCH OUTPUT</b>	One SPDT; switch may be wired "normally open" or "normally closed"
<b>ELECTRICAL RATING</b>	15 A 125/250/480 VAC resistive. Electrical switches have limited DC capabilities. Consult factory for additional information.
<b>WEIGHT</b>	Approx. 1 lb., 8 oz. (0.68 kg.)
<b>ELECTRICAL CONNECTION</b>	1/2" NPT (female)
<b>PRESSURE CONNECTION</b>	All models 1/4" NPT (female) except models S126B-S164B: 1/2" NPT (female)

**APPROVALS**

UE declarations and third-party issued Agency certifications are available for download at [www.ueonline.com/prod\\_approval](http://www.ueonline.com/prod_approval).

 **UNITED STATES AND CANADA**  
 UL Listed,  
 UL 508, file #E42272  
 cUL Certified  
 CSA C22.2 No. 14, file #42272  
 Canadian Registration Number (CRN): Refer to [www.ueonline.com/certifications](http://www.ueonline.com/certifications) for list of approved models

 **RUSSIA**  
**Gosgortekhnadzor Permit (OPTIONAL - Code M406)**  
 OExia IIC T6  
 Tamb. = -50°C to +60°C  
 NANIO CCVE Certification Center  
 Certificate ROSS US.GB05.Bo2933  
 GOST R 51330.0, 51330.1, 51330.10 & 51330.14

 **EUROPEAN UNION**  
**ATEX Directive (94/9/EC)**  
 II 1 G EEx ia IIC T6 **(OPTIONAL - Code M405)**  
 Tamb = -50°C to +60°C  
 UL International DEMKO A/S (N.B.# 0539)  
 Certificate #DEMKO 03 ATEX 0335063  
 EN 50014, 50020 & 50284

 **Low Voltage Directive (LVD) (73/23/EC & 93/68/EEC)**  
 Compliant to LVD  
 Products rated lower than 50 VAC and 75 VDC are outside of the scope of the LVD  
 The Low Voltage Directive does not apply to products for use in hazardous locations

**Pressure Equipment Directive (PED) (97/23/EC)**  
 Compliant to PED  
 Products rated below 7.5 psi are outside the scope of PED



## PRESSURE MODEL CHART

Model	Adjustable Set Point Range		Deadband		Over Range Pressure*		Proof Pressure**	
	Low end of range on fall; High end of range on rise		psi	bar	psi	bar	psi	bar
	psi	bar	psi	bar	psi	bar	psi	bar
	(unless noted)	(unless noted)	(unless noted)	(unless noted)	(unless noted)	(unless noted)	(unless noted)	(unless noted)
Welded 316L stainless steel bellows and 1/2" NPT (female) pressure connection								
S126B	30 "Hg Vac to 0 psi	-1 to 0	0.2 to 0.8 "Hg	6,8 to 27,1 mbar	3	0,2	5	0,3
S134B	30 "Hg Vac to 20 psi	-1 to 1,4	0.2 to 0.8 "Hg	6,8 to 27,1 mbar	20	1,4	25	1,7
S136B	0 to 50" wc	0 to 124,5 mbar	3 to 6 "wc	7,5 to 14,9 mbar	50 "wc	124,5 mbar	5	0,3
S142B	0 to 18	0 to 1,2	4 to 7 "wc	10 to 17,4 mbar	18	1,2	25	1,7
S148B	0 to 40	0 to 2,8	0.1 to 0.4	6,9 to 27,6 mbar	40	2,8	40	2,8
S152B	0 to 50	0 to 3,4	0.1 to 0.5	6,9 to 34,5 mbar	50	3,4	75	5,2
S156B	3 to 100	0,2 to 6,9	0.2 to 0.8	13,8 to 55,2 mbar	100	6,9	125	8,6
S160B	50 to 180	3,4 to 12,4	0.3 to 1	20,7 to 68,9 mbar	180	12,4	180	12,4
S164B	0 to 200	0 to 13,8	0.3 to 2	20,7 to 137,9 mbar	200	13,8	200	13,8
Welded 316L stainless steel bellows and 1/4" NPT (female) pressure connection (Model 680 not recommended for rapid or high cycling pressure changes)								
354	0 to 50	0 to 3,4	1.5 to 2.5	0,1 to 0,2	50	3,4	75	5,2
356	0 to 100	0 to 6,9	2 to 4	0,1 to 0,3	100	6,9	150	10,3
358	0 to 200	0 to 13,8	3 to 5	0,2 to 0,3	200	13,8	250	17,2
360	0 to 250	0 to 17,2	3 to 5	0,2 to 0,3	250	17,2	330	22,8
362	0 to 350	0 to 24,1	2 to 8	0,1 to 0,6	350	24,1	430	29,6
364	0 to 500	0 to 34,5	3 to 9	0,2 to 0,62	500	34,5	575	39,6
680	100 to 1700	6,9 to 117,2	9 to 23	0,6 to 1,6	1700	117,2	2500	172,4
303 stainless steel piston with Buna N O-ring and 303 stainless steel 1/4" NPT (female) pressure connection (not recommended for gas service since drying of the O-ring can allow bleeding of the medium into the atmosphere)								
610	75 to 1000	5,2 to 68,9	30 to 150	2,1 to 10,3	1000	68,9	10,000	689,5
612	125 to 3000	8,6 to 206,8	40 to 250	2,8 to 17,2	3000	206,8	10,000	689,5
614	500 to 6000	34,5 to 413,7	50 to 400	3,4 to 27,6	6000	413,7	10,000	689,5

\* **Over Range Pressure:** The maximum pressure that may be applied continuously without causing damage and maintaining set point repeatability.

\*\* **Proof Pressure:** The maximum pressure to which a pressure sensor may be occasionally subjected, which causes no permanent damage. The unit may require calibration (e.g., start-up, testing).

Model	Adjustable Set Point Range		Deadband		Over Range Pressure*		Proof Pressure**	
	Low end of range on fall; High end of range on rise							
	psi (unless noted)	bar (unless noted)	psi (unless noted)	bar (unless noted)	psi (unless noted)	bar (unless noted)	psi (unless noted)	bar (unless noted)
Brass bellows with nickel-plated brass 1/4" NPT (female) pressure connection†; Models 126 and 134 have zinc-plated steel spring exposed to media								
126	30 "Hg Vac to 0 psi	-1 to 0	0.2 to 0.8 "Hg	6,8 to 27,1 mbar	3	0,2	5	0,3
134	30 "Hg Vac to 20 psi	-1 to 1,4	0.2 to 0.8 "Hg	6,8 to 27,1 mbar	20	1,4	25	1,7
136	0 to 50" wc	0 to 124,5 mbar	3 to 6 "wc	7,5 to 14,9 mbar	50 "wc	124,5 mbar	5	0,3
142	0 to 18	0 to 1,2	4 to 7 "wc	10 to 17,4 mbar	18	1,2	25	1,7
148	0 to 40	0 to 2,8	0.1 to 0.4	6,9 to 27,6 mbar	40	2,8	40	2,8
152	0 to 50	0 to 3,4	0.1 to 0.5	6,9 to 34,5 mbar	50	3,4	75	5,2
156	3 to 100	0,2 to 6,9	0.2 to 0.8	13,8 to 55,2 mbar	100	6,9	125	8,6
160	50 to 180	3,4 to 12,4	0.3 to 1	20,7 to 68,9 mbar	180	12,4	180	12,4
Phosphor bronze bellows with nickel-plated brass 1/4" NPT (female) pressure connection; Model 218 has 300 series stainless steel spring exposed to media								
218	30 "Hg Vac to 0 psi	-1 to 0	1 to 2 "Hg	33,9 to 67,7 mbar	0	0	30	2,1
222	0 to 20	0 to 1,4	0.5 to 1	34,5 to 68,9 mbar	20	1,4	30	2,1
224	0 to 30	0 to 2,1	0.5 to 1	34,5 to 68,9 mbar	30	2,1	45	3,1
226	0 to 50	0 to 3,4	0.7 to 1.3	48,3 to 89,6 mbar	50	3,4	75	5,2
230	0 to 100	0 to 6,9	1 to 2	68,9 mbar to 0,1 bar	100	6,9	110	7,6
258	0 to 50	0 to 3,4	1.5 to 2.5	0,1 to 0,2	50	3,4	75	5,2
266	0 to 100	0 to 6,9	2 to 5	0,1 to 0,3	100	6,9	150	10,3
270	0 to 200	0 to 13,8	3 to 5	0,2 to 0,3	200	13,8	250	17,2
272	0 to 250	0 to 17,2	3 to 5	0,2 to 0,3	250	17,2	330	22,8
274	0 to 300	0 to 20,7	4 to 6	0,3 to 0,4	300	20,7	350	24,1

†Several of these models were previously offered with adjustable deadband as J6D. Specify option code 1520 if adjustable deadband is required.



# J6 Series

J6 Series

## HOW TO ORDER

### BUILDING A PART NUMBER

#### Select a **Type**

Refer to the "Type" section below.

Determine type number based on switch output, enclosure, adjustment and reference.

Fill in the type portion of your part number with the corresponding number.

#### Select a **Model**

Refer to the "Model Charts".

Determine model based on adjustable range, deadband and proof pressure.

Fill in the model portion of your part number with the corresponding number.

#### Select an **Option**

Refer to the "Options" section.

Determine option number based on switch output, optional materials or other product enhancements.

Fill in the option portion of your part number with the corresponding number.

Leave "option" portion blank if no options are needed. *FOR MULTIPLE OPTIONS:* Call United Electric Controls.

TYPE	DESCRIPTION
Pressure	<b>Type J6</b> - One SPDT output; epoxy coated enclosure; internal adjustment with no reference dial

### SWITCH OPTIONS\*

0140	Gold contacts, 1 A 125 VAC resistive
0500	Close deadband, 5 A 125/250 VAC resistive
1070	10 A 125 VDC resistive; deadband and minimum set point will increase
1520	Adjustable deadband, 15 A 125/250/277 VAC resistive. Adjustment wheel changes rise setting only - if adjustment on fall setting is required, use primary adjustment. NOT AVAILABLE ON MODELS 258-274, 354-364, 610-614, 680. NOTE: Must select this option for models previously listed as J6D.
1530	External manual reset, 15 A 125/250/480 VAC resistive, latches on rising pressure only
2000	20 A 125/250/480 VAC resistive

### SENSOR AND OTHER OPTIONS

M201	Factory set one switch; specify increasing or decreasing pressure and set point
M277	Range indicated on nameplate in kPa or MPa factory selected
M278	Range indicated on nameplate in Kg/cm <sup>2</sup>
M405	Intrinsic safety compliance for European Union per ATEX standards
M406	Intrinsic safety compliance for Russia per Gosgortekhnadzor standards
M444	Paper ID tag
M446	Stainless steel ID tag & wire attachment
M540	Viton® construction (deadband and low end of range may increase); wetted parts include Viton® O-ring and standard connection material. AVAILABLE ON MODELS 610-614 ONLY
M550	Oxygen service cleaning; alcohol cleaning to remove residue from the process connection
M913	1/4" NPT (female) 316L stainless steel pressure connection. AVAILABLE MODELS S126B-S164B
M914	1/2" NPT (female) 316L stainless steel pressure connection. AVAILABLE MODELS 354-364

\* All switches have limited DC capabilities. Consult factory for details.

Viton® is a registered trademark of E.I. duPont de Nemours and Company

**DIMENSIONAL DRAWINGS**

Dimensional drawings for all models may be found at [www.ueonline.com](http://www.ueonline.com)

**Internal Set Point Adjustment**

Types J6

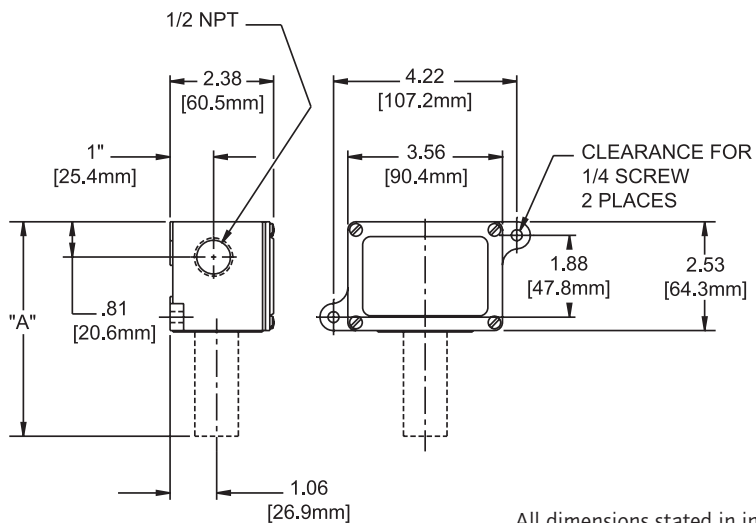

All dimensions stated in inches (millimeters)

Models	Dimension A		
	Inches	mm	NPT
126-160	5.06	128.5	1/4
S126B-S164B	5.47	138.9	1/2
218-230	4.31	109.5	1/4
258-274	4.75	120.7	1/4
354-364	4.78	121.4	1/4
610-614	5.72	145.3	1/4
680	4.97	126.2	1/4

**Pressure Sensors**

**Models 218-230**

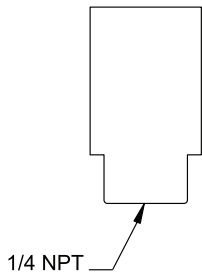

**Models 126-160**

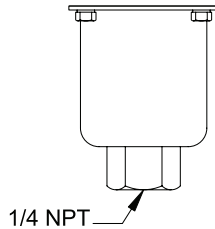

**Models S126B-S164B**

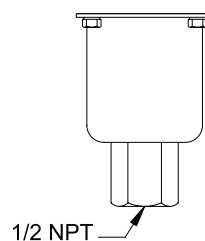

**Models 610-614**

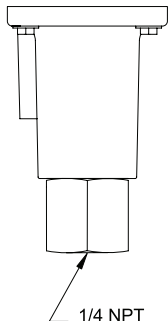

**Models 258-274**

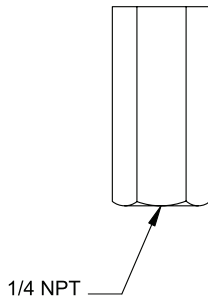

**Models 354-364, 680**

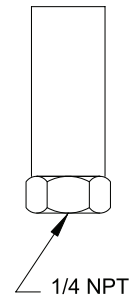



## RECOMMENDED PRACTICES AND WARNINGS

United Electric Controls Company recommends careful consideration of the following factors when specifying and installing UE pressure and temperature units. Before installing a unit, the Installation and Maintenance instructions provided with unit must be read and understood.

- To avoid damaging unit, proof pressure and maximum temperature limits stated in literature and on nameplates must never be exceeded, even by surges in the system. Operation of the unit up to maximum pressure or temperature is acceptable on a limited basis (e.g., start-up, testing) but continuous operation must be restricted to the designated adjustable range. Excessive cycling at maximum pressure or temperature limits could reduce sensor life.
- A back-up unit is necessary for applications where damage to a primary unit could endanger life, limb or property. A high or low limit switch is necessary for applications where a dangerous runaway condition could result.
- The adjustable range must be selected so that incorrect, inadvertent or malicious setting at any range point cannot result in an unsafe system condition.
- Install unit where shock, vibration and ambient temperature fluctuations will not damage unit or affect operation. When applicable, orient unit so that moisture does not enter the enclosure via the electrical connection. When appropriate, this entry point should be sealed to prevent moisture entry.
- Unit must not be altered or modified after shipment. Consult UE if modification is necessary.
- Monitor operation to observe warning signs of possible damage to unit, such as drift in set point or faulty display. Check unit immediately.
- Preventative maintenance and periodic testing is necessary for critical applications where damage could endanger property or personnel.
- Electrical ratings stated in literature and on nameplate must not be exceeded. Overload on a switch can cause damage, even on the first cycle. Wire unit according to local and national electrical codes, using wire size recommended in installation sheet.
- Do not mount unit in ambient temp. exceeding published limits.

## LIMITED WARRANTY

Seller warrants that the product hereby purchased is, upon delivery, free from defects in material and workmanship and that any such product which is found to be defective in such workmanship or material will be repaired or replaced by Seller (Ex-works, Factory, Watertown, Massachusetts. INCOTERMS); provided, however, that this warranty applies only to equipment found to be so defective within a period of 24 months from the date of manufacture by the Seller. Seller shall not be obligated under this warranty for alleged defects which examination discloses are due to tampering, misuse, neglect, improper storage, and in any case where products are disassembled by anyone other than authorized Seller's representatives. EXCEPT FOR THE LIMITED WARRANTY OF REPAIR AND REPLACEMENT STATED ABOVE, SELLER DISCLAIMS ALL WARRANTIES WHATSOEVER WITH RESPECT TO THE PRODUCT, INCLUDING ALL IMPLIED WARRANTIES OF MERCHANTABILITY OR FITNESS FOR ANY PARTICULAR PURPOSE.

## LIMITATION OF SELLER'S LIABILITY

SELLER'S LIABILITY TO BUYER FOR ANY LOSS OR CLAIM, INCLUDING LIABILITY INCURRED IN CONNECTION WITH (I) BREACH OF ANY WARRANTY WHATSOEVER, EXPRESSED OR IMPLIED, (II) A BREACH OF CONTRACT, (III) A NEGLIGENT ACT OR ACTS (OR NEGLIGENT FAILURE TO ACT) COMMITTED BY SELLER, OR (IV) AN ACT FOR WHICH STRICT LIABILITY WILL BE INPUTTED TO SELLER, IS LIMITED TO THE "LIMITED WARRANTY" OF REPAIR AND/OR REPLACEMENT AS SO STATED IN OUR WARRANTY OF PRODUCT. IN NO EVENT SHALL THE SELLER BE LIABLE FOR ANY SPECIAL, INDIRECT, CONSEQUENTIAL OR OTHER DAMAGES OF A LIKE GENERAL NATURE, INCLUDING, WITHOUT LIMITATION, LOSS OF PROFITS OR PRODUCTION, OR LOSS OR EXPENSES OF ANY NATURE INCURRED BY THE BUYER OR ANY THIRD PARTY.

*UE specifications subject to change without notice.*

FOR A LIST OF OUR INTERNATIONAL AND DOMESTIC  
REGIONAL SALES OFFICES PLEASE VISIT OUR  
WEBPAGE [WWW.UEONLINE.COM](http://WWW.UEONLINE.COM)



UNITED ELECTRIC  
CONTROLS

180 Dexter Avenue, P.O. Box 9143  
Watertown, MA 02471-9143 USA  
Telephone: 617 926-1000 Fax: 617 926-2568  
<http://www.ueonline.com>